



BIENVENIDO A NUESTRO  
**CATÁLOGO DIGITAL**



PUEDES VISITAR NUESTRA  
**PAGINA WEB**

[www.fermetal.com.do](http://www.fermetal.com.do)



- Canal
- Bajante
- Unión Canal
- Unión Canal Bajante
- Esquina Exterior
- Esquina Interior
- Soporte Canal
- Tapa Exterior Der/Izq
- Tapa Interior Der/Izq
- Unión Bajante
- Codo Bajante 90°
- Codo Bajante 45°
- Soporte Bajante
- Adaptador Bajante



# SISTEMA DE CANALES Y BAJANTES EN PVC



Escanea para ver  
el video instructivo

## Esquema de canal

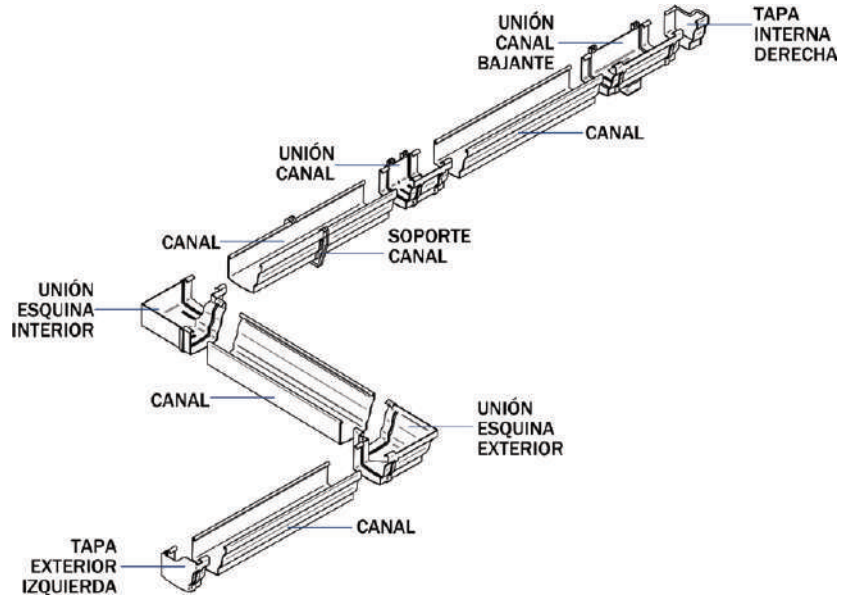

## Esquema de bajante cuadrado

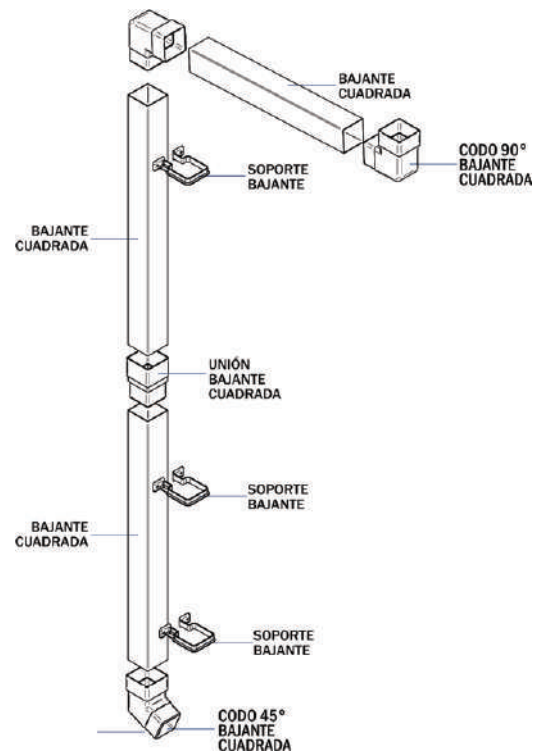



Canal para desagüe de 3mts  
Ancho de 12 cm

Código	Medida	Diagrama
--------	--------	----------

TUBPL5001 **PIEZA**



Unión para canal

Código	Medida	Diagrama
--------	--------	----------

TUBPL5011 **PIEZA**



Unión para canal bajante

Código	Medida	Diagrama
--------	--------	----------

TUBPL5016 **PIEZA**

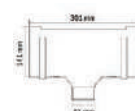

Esquina Interior

Código	Medida	Diagrama
--------	--------	----------

TUBPL5012 **PIEZA**

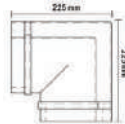

Esquina Exterior

Código	Medida	Diagrama
--------	--------	----------

TUBPL5013 **PIEZA**

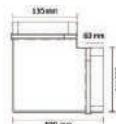

Soporte para canal

Código	Medida	Diagrama
--------	--------	----------

TUBPL5017 **PIEZA**

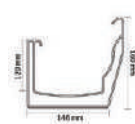

Tapa Exterior izquierda

Código	Medida	Diagrama
--------	--------	----------

TUBPL5015 **PIEZA**

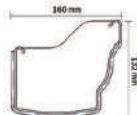

Tapa Exterior derecha

Código	Medida	Diagrama
--------	--------	----------

TUBPL5014 **PIEZA**

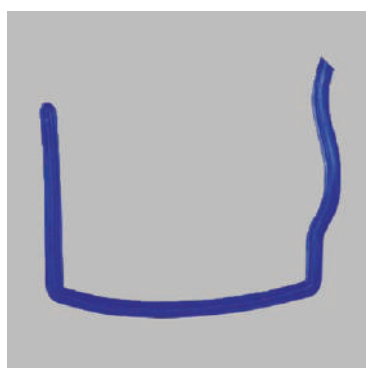
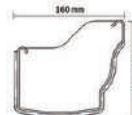

Sello elastomérico

Código	Medida	Diagrama
--------	--------	----------

TUBPL5018 **PIEZA**





Tubo cuadrado bajante  
2-1/2" - 65x65 mm - largo: 3m

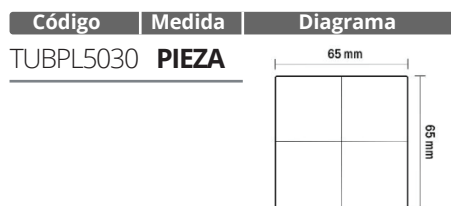

Unión para tubo cuadrado bajante



Unión para tubo 45° cuadrado bajante

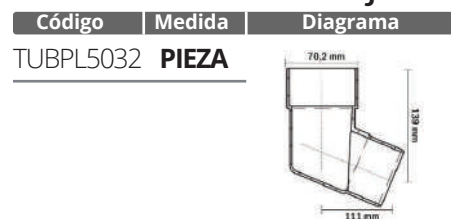

Codo 90° para tubo Cuadrado bajante

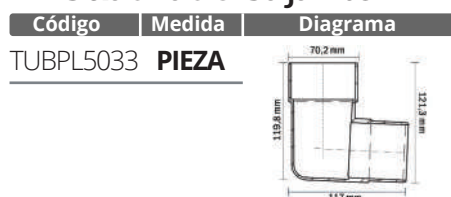

Soporte para tubo cuadrado bajante

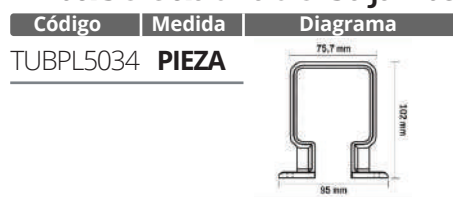

Adaptador para tubo redondo

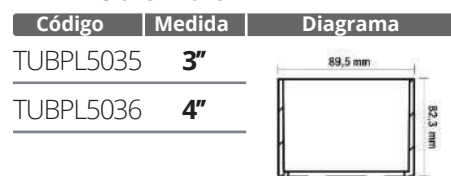

## PARA CLOSET Y CORTINAS

### Tubos de Aluminio Pulido Acabado Brillante



Código	Descripción	UDM
FM 81 1001	<b>1/2"</b> x 3 mts / 10ft	PAQ 12 pzs
FM 81 1002	<b>5/8"</b> x 3 mts / 10ft	PAQ 10 pzs
FM 81 1003	<b>3/4"</b> x 3 mts / 10ft	PAQ 06 pzs
FM 81 1004	<b>1"</b> x 3 mts / 10ft	PAQ 04 pzs

UNIDAD DE MEDIDA: PIEZA

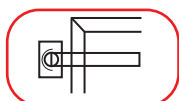
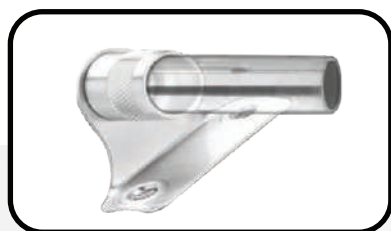

•Instalación Pared Externa



#### Soporte Curvo

Código	Descripción
FM 81 0001	1/2"
FM 81 0002	5/8"
FM 81 0003	3/4" (Tubo EMT 1/2")
FM 81 0004	1" (Tubo EMT 3/4")

UNIDAD DE MEDIDA: 1 PAR  
SUB-EMPAQUE: 25 PARES

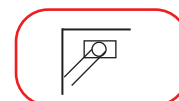
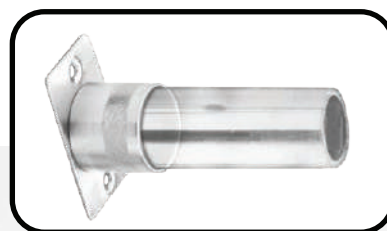

•Instalación Pared Interna



#### Soporte Recto

Código	Descripción
FM 81 0011	1/2"
FM 81 0012	5/8"
FM 81 0013	3/4" (Tubo EMT 1/2")
FM 81 0014	1" (Tubo EMT 3/4")

UNIDAD DE MEDIDA: 1 PAR  
SUB-EMPAQUE: 25 PARES

## PARA CLOSET Y CORTINAS



### Soporte para Tubo de Cortina y Closet

Código	REF	Descripción
FM 81 0131	SOP-05	3/4" (Tubo EMT 1/2")
FM 81 0133	SOP-04	1" (Tubo EMT 3/4")

UNIDAD DE MEDIDA: 1 PAR  
SUB-EMPAQUE: 25 PARES

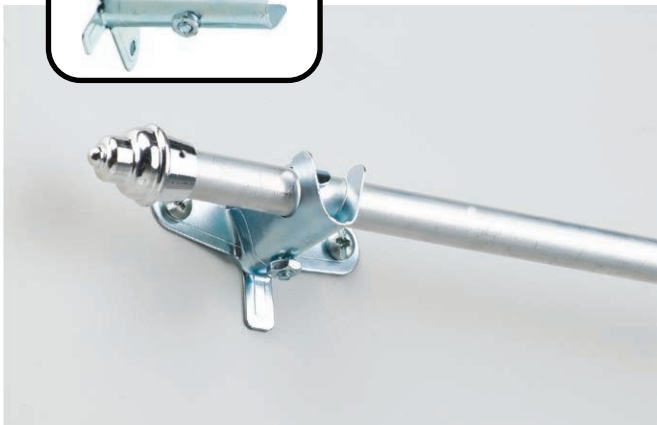
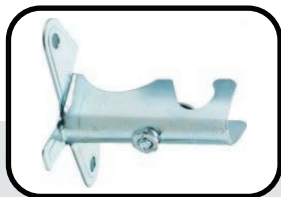
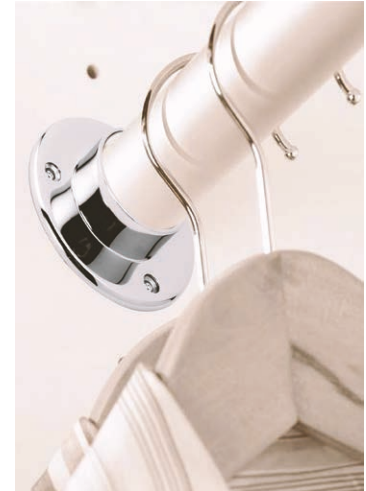

### Soporte Sencillo

Código	Descripción
FM 81 0111	1/2"

UNIDAD DE MEDIDA: 1 PAR  
SUB-EMPAQUE: 25 PARES



### Soporte Doble

Código	Descripción
FM 81 0121	1/2"

UNIDAD DE MEDIDA: 1 PAR  
SUB-EMPAQUE: 25 PARES

- Soporta mayor peso (**1 sola pieza**)
- Se puede usar como soporte medio para tubos largos (**Techo o pared**)



## Soporte Pasante

Código	Descripción
FM 81 0023	3/4" (Tubo EMT 1/2")
FM 81 0024	1" (Tubo EMT 3/4")

UNIDAD DE MEDIDA: 1 PAR  
SUB-EMPAQUE: 25 PARES

## PARA CLOSET Y CORTINAS

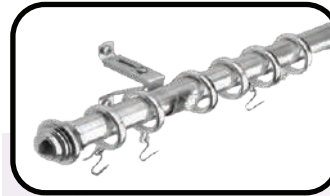

## Soporte Extensible

Código	Descripción
FM 81 0033	3/4" (Tubo EMT 1/2")
FM 81 0034	1/2" (Tubo EMT 3/4")

UNIDAD DE MEDIDA: 1 PAR  
SUB-EMPAQUE: 25 PARES



## Soporte para Techo

Código	Descripción
FM 81 0101	1/2"

UNIDAD DE MEDIDA: 1 PAR  
SUB-EMPAQUE: 25 PARES



## Tope Decorativo

Código	Descripción
FM 81 0151	1/2"
FM 81 0152	5/8"
FM 81 0153	3/4"
FM 81 0154	1"

UNIDAD DE MEDIDA: 1 PAR  
SUB-EMPAQUE: 25 PARES





•Fácil instalación



•Instalación Pared Externa



Incluye:  
•Tarugos  
•Soportes  
•Tornillos



# DISPONIBLE NUESTRO KIT DE CORTINERO EXTENSIBLE

## Tamaños Disponibles

FM 81 2002	2'	60cm	○	—	a	—	○	90 cm	3'
FM 81 2003	3'	90cm	○	—	a	—	○	120 cm	4'
FM 81 2004	4'	120cm	○	—	a	—	○	180 cm	6'
FM 81 2005	6'	180cm	○	—	a	—	○	240 cm	8'



Materials Eléctricos



# Duchas eléctricas

¡Lo bueno también evoluciona!

[www.fermetal.com.do](http://www.fermetal.com.do)

# Enerbras®

Materiais Eléctricos

# FERMETAL

## Duchas eléctricas



DUCHA ELECTRICA 3 TEMPERATURAS

Código	Descripción
--------	-------------

ENER0001	5400w 100V *BLANCA*
----------	---------------------

ENER0002	5400w 100V *AZUL*
----------	-------------------

ENER0003	5400w 100V *AMARILLA*
----------	-----------------------

ENER0004	5400w 100V *ROJO VINO*
----------	------------------------



# Enerbras®

Materiais Eléctricos



BRAZO DE DUCHA ELECTRICA

Código	Descripción
--------	-------------

ENER0051	30 cm
----------	-------



BRAZO DE DUCHA ELECTRICA

Código	Descripción
--------	-------------

ENER0052	40 cm
----------	-------



RESISTENCIA PARA DUCHA ELECTRICA

Código	Descripción
--------	-------------

ENER0061	5,400W 100V
----------	-------------



# CATÁLOGO ELECTRICIDAD





**FM 01 3003 ENC-03**  
Enchufe adaptador P/ Taladro  
15 AMP



**FM 01 3006 ENC-08**  
Enchufe de goma industrial  
15 AMP



**FM 01 3007 ENC-09**  
Enchufe industrial polarizado  
15 AMP



**FM 01 3075 TOM-10**  
Toma embutir T/32  
3 x 50 AMP



**FM 01 3008 ENC-10**  
Enchufe angular trifasico  
50 AMP



**FM 01 3009 CON-20**  
Enchufe convertidor europeo-  
americano 15 AMP



**FM 01 302 TOM-14**  
Toma sin tierra amarilla vinil  
15 AMP



**FM 01 3103 TOM-15**  
Toma polarizada amarilla  
15 AMP



**FM 01 3022 ENC-16**  
Enchufe polarizado de metal vinil  
15 AMP



**FM 01 3020 ENC-14**  
Enchufe sin tierra amarillo  
15 AMP



**FM 01 3021 ENC-15**  
Enchufe polarizado amarillo  
15 AMP



**FM 01 3001 BEN-01**  
Enchufe de goma triple, 2 enchufe + 1 toma,  
blanco mod-400 15 AMP

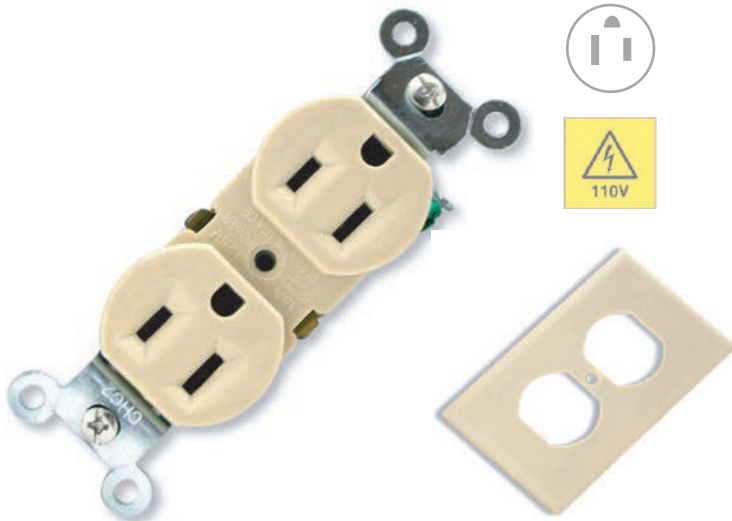

**FM 01 3050 TOM-01**  
Toma doble polarizada 270  
Beige 15AMP

**FM 01 3055 TAP-25**  
Tapa para toma doble 270  
Beige



**FM 01 3051 TOM-07**  
Toma doble polarizada 270  
Blanco 15 AMP

**FM 01 3056 TAP-26**  
Tapa para toma doble 270  
Blanca

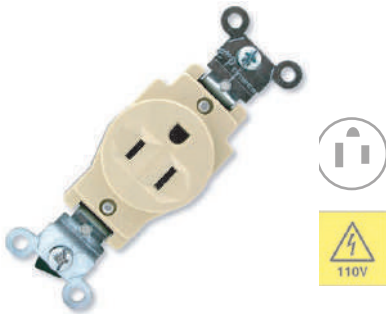

**FM 01 3090 TOM-26**  
Toma polarizada T/817  
15 AMP

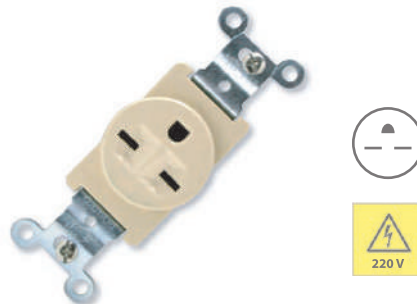

**FM 01 3092 TOM-25**  
Toma polarizada  
20 AMP



**FM 01 3065 TOM-49**  
Toma de sobreponer  
doble polarizada



**FM 01 0510 CLO-50**  
Closter con cadena doble toma  
Tipo 718 15 AMP



**FM 01 3110 REG-90**  
Regleta 6 tomas polarizadas C/interreputor  
15 AMP



**FM 01 2110 INT-94**  
Interruptor sencillo sobreponer

**FM 01 2111 INT-95**  
Interruptor de sobreponer 3 vías



**FM 01 2050 INT-87**  
Interruptor sencillo  
**1 vía**



**FM 01 2051 INT-88**  
Interruptor sencillo  
**3 vías**



**FM 01 2052 INT-89**  
interruptor doble



**FM 01 2053 INT-90**  
Interruptor triple



**FM 01 2055 INT-93**  
Interruptor timbre

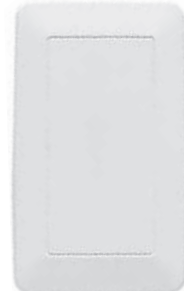

**FM 01 2060 TAP-82**  
Tapa ciega



**FM 01 2057 TOM-44**  
Toma doble polarizada  
15 AMP



**FM 01 2056 TOM-42**  
Toma sencilla polarizada  
15 AMP



**FM 01 2058 TOM-45**  
Toma de telefono



**FM 01 2061 TOM-101**  
Toma doble: Americana polarizada +  
USB



**FM 01 2054 INT-91**  
Interruptor + Toma polarizada





**FM 01 0500 SOC-01**  
Sócate de goma reforzado E27



**FM 01 0501 SOC-02**  
Sócate de porcelana para Niple E27



**FM 01 0502 SOC-18**  
Sócate porcelana estrella E27



**FM 01 0505 SOC-08**  
Sócate de porcelana E-27 con macho



**FM 01 0550 SOC-41**  
Sócate de seguridad para tubo lineal, LED y flourescente.

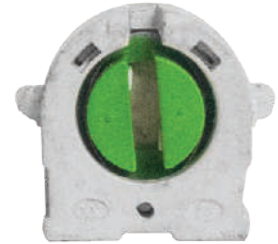

**FM 01 0555 SOC-100**  
Sócate para lampara parabólica (LAM-177/ 178)



**FM 01 0520 REC-45**  
Receptáculo bakelita 2 1/2" / E-27



**FM 01 0522 REC-43**  
Receptáculo bakelita 4 1/2" / E-27



**FM 01 0540 REC-44-RD**  
Receptáculo porcelana 4 1/2" / E-27



**FM 01 0180 BAS-51**  
Base para bombillo tipo reflector E-27 sencillo



**FM 01 0181 BAS-52**  
Base para bombillo tipo reflector E-27 doble







LED Ojo de buey 110 - 220 V Luz fria

**FM 01 0200** LAM-303 6W ; 3.5"

**FM 01 0205** LAM-304 12W ; 5"



Lámpara de embutir panel LED 36w

**FM 01 0275** PAN-01 24" x 24"



**FM 01 0121** BAS-53

Base para fotocelula con soporte



**FM 01 0123** FOT-10

Fotocelda 110- 220v 15A



Lámpara auxiliar  
para mecánico

**FM 01 0141** LAM-81 15 FT

**FM 01 0142** LAM-82 25 FT

**FM 01 0143** LAM-83 50 FT



**FM 01 4040** PRO-20

Probador de tensión de dos patas  
T/914 6002 ; 110V - 220V

## Reflectores LED



**FM 01 0251**  
Reflector LED 10 W



**FM 01 0252**  
Reflector LED 20 W



**FM 01 0253 REF-C30**  
Reflector LED 30 W



**FM 01 0255 REF-C50**  
Reflector LED 50 W



**FM 01 0257 REF-C100**  
Reflector LED 100 W



**FM 01 0257 REF-C150**  
Reflector LED 150 W



Reflectores en uso



Cajetín para embutir Rectangular 4"x2"		
DUR70001	21000	Rectangular

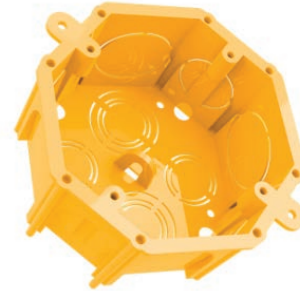

Cajetín para embutir Octogonal		
DUR70002	21002	Octogonal



Adaptador macho para caja con tuerca	
TBPL0001	<b>1/2"</b>
TBPL0002	<b>3/4"</b>



Curva PVC	
TBPL0011	<b>1/2"</b>
TBPL0012	<b>3/4"</b>



Canaleta		
FM 01 1150	CAN-11	10mm x 10mm
FM 01 1151	CAN-12	15mm x 15mm
FM 01 1152	CAN-13	20mm x 20mm
FM 01 1153	CAN-14	30mm x 13mm



## Extractores



**FM 01 4020** EXT-100  
Extractor de aire 8" - 40w ; 2,800 RPM

**FM 01 4021** EXT-101  
Extractor de aire 10" - 40w ; 2,800 RPM

**FM 01 4022** EXT-102  
Extractor de aire 12" - 40w ; 2,800 RPM



Ducto de ventilación de aluminio para extractores

**FM 01 4046** TUB-103 4" 6.5ft / 2mts

**FM 01 4045** TUB-102 4" 5ft / 1.5mts



**FM 01 4030** EXT-103  
Extractor de aire con rejilla 8" - 120V - 30W ; Centrifugo

**FM 01 4031** EXT-104  
Extractor de aire con rejilla 10" - 120V - 40W ; Centrifugo

## Protectores



**FM 55 0013** PRO-58  
Protector para aire acondicionado,  
hasta 12000 BTU, 220V.



**FM 55 0011** PRO-56  
Protector de nevera de uso  
doméstico, 110V.



**FM 55 0012** PRO-57  
Protector regleta 4 tomas  
multiusos, 110V.



**FM 55 0014** PRO-59  
Protector para TV de uso doméstico  
110V.



Desde



hasta



## SWITCH TIPO MACHETE

- FM 02 0001** CUC-55 2 X 30 A
- FM 02 0005** CUC-60 2 X 60 A
- FM 02 0010** CUC-65 2 X 100 A
- FM 02 0027** CUC-82 2 X 30 A Doble Tiro
- FM 02 0028** CUC-83 2 X 60 A Doble Tiro
- FM 02 0029** CUC-84 2 X 100A Doble Tiro



Desde



hasta



## SWITCH TIPO MACHETE

- FM 02 0015** CUC-70 3 X 30 A
- FM 02 0020** CUC-75 3 X 60 A
- FM 02 0025** CUC-80 3 X 100A



Desde



hasta



## SWITCH DOBLE TIRO

- FM 02 0030** CUC-86 3 X 30 A
- FM 02 0035** CUC-87 3 X 60 A
- FM 02 0040** CUC-88 3 X 100 A



Desde



hasta



## SWITCH DOBLE TIRO

- FM 02 0027** 2 X 30 A
- FM 02 0028** 2 X 60 A
- FM 02 0029** 2 X 100 A



**FM 01 0164**

**LUM - 01**

Luminaria tipo alumbrado público con brazo,  
E-27 (1 bombillo) 65W



**FM 01 0165**

**LUM - 02**

Luminaria tipo alumbrado público con brazo,  
E-27 (2 Bombillos) 65W

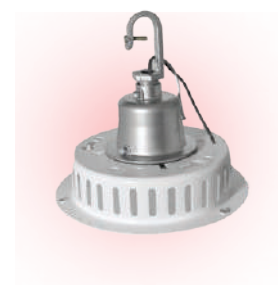

**FM 01 0151 ; KIT - 100**

Lámpara industrial policarbonato de **22"**, E-27, con PLA - 01  
(plato) Y BAS- 05 (base)

**FM 01 0153 ; KIT - 101**

Lámpara industrial policarbonato de **16"**, E-27, con PLA - 01  
(plato) Y BAS- 05 (base)

**FM 01 0155 ; KIT - 102**

Lámpara industrial policarbonato de **12"**, E-27, con PLA - 02  
(plato) Y BAS- 05 (base)

## FLEXIBLES EN POLIETILENO



TUBERIA FLEXIBLE CORRUGADA (NEGRA)

Código: PVC CR 001 TUBERIA CORRUGADA 1/2"	U de M ROLLO de 100 pies
Código: PVC CR 002 TUBERIA CORRUGADA 3/4"	
Código: PVC CR 003 TUBERIA CORRUGADA 1"	



TUBERIA FLEXIBLE CORRUGADA (GRIS)

Código: PVC CR 011 TUBERIA CORRUGADA 1/2"	U de M ROLLO de 100 pies
Código: PVC CR 012 TUBERIA CORRUGADA 3/4"	
Código: PVC CR 013 TUBERIA CORRUGADA 1"	



TUBERIA FLEXIBLE CORRUGADA (MARRÓN)

Código: PVC CR 061 TUBERIA CORRUGADA 1/2"	U de M ROLLO de 100 pies
---	--------------------------------



TUBERIA FLEXIBLE CORRUGADA (AZUL)

Código: PVC CR 021 TUBERIA CORRUGADA 1/2"	U de M ROLLO de 100 pies
Código: PVC CR 022 TUBERIA CORRUGADA 3/4"	



TUBERIA FLEXIBLE CORRUGADA (ROJO)

Código: PVC CR 031 TUBERIA CORRUGADA 1/2"	-	U de M ROLLO de 100 pies
Código: PVC CR 032 TUBERIA CORRUGADA 3/4"	-	



TUBERIA FLEXIBLE CORRUGADA (AMARILLA)

Código: PVC CR 041 TUBERIA CORRUGADA 1/2"	-	U de M ROLLO de 100 pies
Código: PVC CR 042 TUBERIA CORRUGADA 3/4"	-	

PARA INSTALACIONES	Negro	Azul	Roja	Amarillo	Gris
Electricas en general	●				●
Agua caliente			●		
Intercom		●			
Audio/Video		●			
Agua Fría		●			
Gas				●	



Bombillo LED

PRV 00 100 TCLEDO7 A60 7W  
 PRV 00 101 TCLEDO9 A60 9W



Bombillo bajo consumo mini-espiral

PRV 00 212 - 20W Luz Blanca 6500k



Bombillo bajo consumo 3U

PRV 00 205 24W LUZ BLANCA 6500K



Bombillo bajo consumo Espiral

PRV 00 225 24W LUZ BLANCA 6500K  
 PRV 00 229 65W LUZ BLANCA 6500K







# PRODUCTOS LED

# PRODUCTOS LED



E27

Bombillo LED A60 E27

Código: HB LED 001. LED (5W)

Código: HB LED 002. LED (7W)

Código: HB LED 003. LED (9w)



E27

Bombillo LED A19 E27

Bombillo LED A19 (9.5W) 2700° K \*Dimmeable\*  
Código: HB LED 013

50,000 MIL HORAS DE VIDA ÚTIL



E12

Bombillo LED vela

LED 5W 2700° K, luz calida  
Código: HB LED 021

\*Dimmeable\*

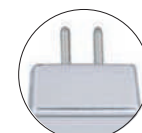

MR-16

LED Dicroico MR-16

LED (4W) 3000° K, luz calida  
Código: HB LED 031

LED (6W) 3000° K, luz calida  
Código: HB LED 033



GU10

LED Dicroico GU10

LED (4.5W) 2700°K Luz calida  
Código: HB LED 041

\*Dimmeable\*

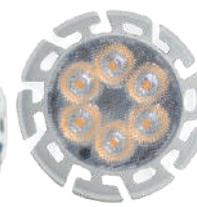

GU10

LED Dicroico GU10

LED (4.5W) 4000°K Luz calida  
Código: HB LED 043

\*Dimmeable\*



50,000 MIL HORAS DE VIDA ÚTIL



**Bombillo LED PAR 20**

LED (7W) 2700°K Luz calida  
Código: HB LED 051

\*Dimmeable\*

LED (7w) 4000°K Luz Fría  
Código: HB LED 053

\*Dimmeable\*



E27



**Bombillo LED PAR 30**

LED (10W) 2700°K Luz calida  
Código: HB LED 061

\*Dimmeable\*



E27



**Bombillo LED PAR 30**

LED (13W) 4000°K Luz Fría  
Código: HB LED 063

\*Dimmeable\*



E27



**Bombillo LED PAR 38**

LED (18W) 4000°K Luz fría  
Código: HB LED 071

\*Dimmeable\*

LED (20w) 4000°K Luz Fría  
Código: HB LED 073

\*Dimmeable\*



E27



**Lámpara DOWNLIGHT**

LED (9W) 5" 4000°K, Luz fría  
Código: HB LED 101

LED (15W) 7" 4000°K, Luz fría  
Código: HB LED 103



E27



**Panel LED de 24"**

LED 24" (22W) **2 luces**  
Código: HB LED 111

LED 24" (33W) **3 luces**  
Código: HB LED 113

## CATÀLOGO DE PRODUCTOS



ISO 9001

BUREAU VERITAS  
Certification



## SCH40 VÁLVULA DE BOLA PESADA



Lisa

### Códigos Medidas

PCP01001	1/2"
PCP01002	3/4"
PCP01003	1"
PCP01005	1 1/2"
PCP01006	2"

A Tapón perilla en PP

B Tornillo en acero cromado

C Perilla en PVC

D O'ring en Nitrilo

E Cuerpo PVC rígido virgen

F Esfera en POM auto lubricada

G Empaques caucho termoplástico



## SCH40 VÁLVULA DE BOLA PESADA CON MANILLA LARGA



Lisa

### Códigos Medidas

PCP01021	1/2"
PCP01022	3/4"
PCP01023	1"
PCP01025	1 1/2"
PCP01026	2"

A Tapón manija en PP

B Tornillo en acero cromado

C Manija larga en PVC

D O'rings en nitrilo

E Esfera en POM auto lubricada

F Cuerpo PVC rígido virgen

G Empaques caucho termoplástico



## VÁLVULA DE BOLA PESADA CON MANILLA LARGA

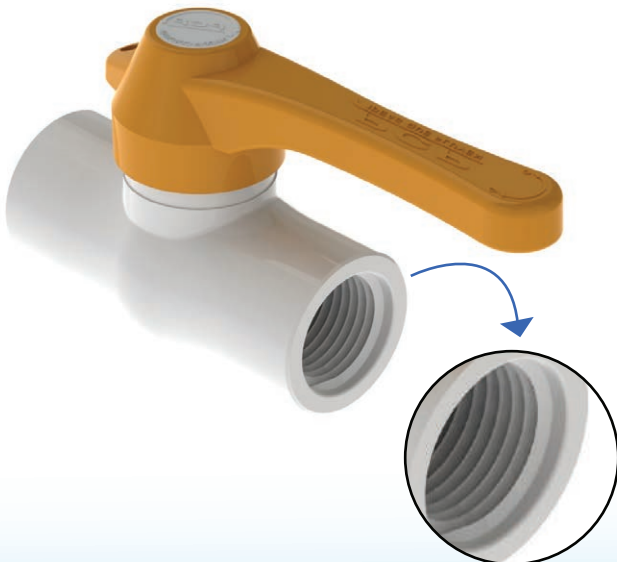

Roscada

### Códigos Medidas

PCP01031	1/2"
PCP01032	3/4"

#### DATOS TÉCNICOS

1. Fácil instalación y sin herramientas.
2. Alta resistencia a la corrosión y al desgaste.
3. No reduce el flujo y evita las pérdidas de presión.
4. Apertura y cierre rápido.
5. Cuerpo compacto tipo liviano.
6. Cuerpo y manija en PVC rígido.
7. O'ring de Nitrilo.
8. Empaque caucho termoplástico.
9. Espesores de cédula 40.
10. Presentación máximo de trabajo:  
150 Psi a 23°C en válvulas de soldar y roscar.
12. Cumple normatividad NTC 1339 (ASTMD2466)



Esesor de pared  
SCH 80  
Cedulación 80  
Norma:  
ASTM 2467  
NTC 4404  
**235** PSI TRABAJO



Esesor de pared  
SCH 40  
Cedulación 40  
Norma:  
ASTM 2466  
NTC 1339  
**150** PSI TRABAJO

(Inserto Bronce Cromado)

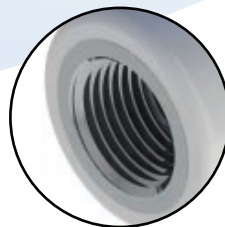

Lisa



## SCH80 VÁLVULA DE BOLA REFORZADA

Códigos Medidas

PCP01051 1/2"

PCP01052 3/4"

PCP01053 1"

PCP01055 1 1/2"

PCP01056 2"

A Tapón perilla en PP

B Tornillo en acero cromado

C Perilla en PVC

D O'rings en nitrilo

E Esfera en POM auto lubricada

F Cuerpo PVC rígido virgen

G Empaques caucho termoplástico



## VÁLVULA DE BOLA PESADA

Códigos Medidas

PCP01501 1/2"

PCP01502 3/4"

### DATOS TÉCNICOS

- Ideal para reemplazar las válvulas metálicas.
- Diseño exclusivo con manija larga más resistente
- Fácil instalación y sin herramientas.
- Alta resistencia a la corrosión y al desgaste.
- Apertura y cierre rápido en 1/4 de giro.
- Cuerpo compacto, robusto y tipo pesado de alta resistencia.
- Rosca en bronce DZR tipo NPT.
- Cuerpo en PVC con inserto metálico.
- O'ring de Nitrilo.
- Empaque caucho termoplástico.
- Espesores de cédula 80.
- Presentación roscar.
- Presión máxima de trabajo de 235 psi a 23°C.
- Cumple normatividad ASTM D2467.)



## VÁLVULA DE BOLA \*ALTA PRESIÓN\*

Códigos Medidas

PCP01066 2" Para soldar de **Una**



## VÁLVULA DE BOLA \*ALTA PRESIÓN\*

Códigos Medidas

PCP01076 2" Para soldar **Doble**

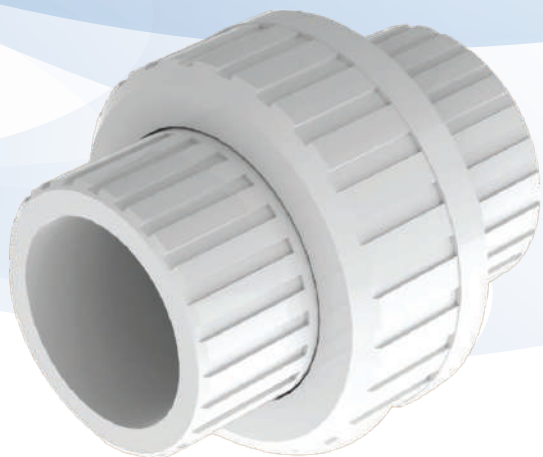

**Lisa**

## SCH40 UNIÓN UNIVERSAL LISA

Códigos	Medidas
PCP00001	1/2"
PCP00002	3/4"
PCP00003	1"

### DATOS TÉCNICOS

1. Fácil instalación, sin herramientas.
2. Cuerpo fabricado en PVC rígido de alta resistencia.
3. Giro suave de la tuerca.
4. Precisión de la cavidad para el o'ring que evita que este se caiga.
5. Presentación roscar y soldar.
6. No reduce el flujo y evita las pérdidas de presión.
7. Rosca tipo NPT.
8. Presión máxima de trabajo:  
235 psi a 23°C en uniones roscar.  
150 psi a 23°C en uniones soldar.
9. Las roscas siguen la normatividad ANSI B1.20.1.
10. Cumple normatividad ASTM D2466- Soldar
11. Cumple normatividad ASTM D2467- Roscar



**(Inserto Bronce Cromado)**

## VÁLVULA CHECK INSERTO BRONCE CROMADO

Códigos	Medidas
PCP03101	1/2"
PCP03102	3/4"

### DATOS TÉCNICOS

1. Fácil instalación y sin herramientas.
2. Alta resistencia a la corrosión y al desgaste.
3. No reduce el flujo y evita las pérdidas de presión.
4. Apertura y cierre rápido.
5. Cuerpo compacto tipo liviano.
6. Cuerpo y manija en PVC rígido.
7. O'ring de Nitrilo.
8. Empaque caucho termoplástico.
9. Espesores de cédula 40.
10. Presentación máximo de trabajo:  
150 Psi a 23°C en válvulas de soldar y roscar.
12. Cumple normatividad NTC 1339 (ASTMD2466)

Con Válvula Check

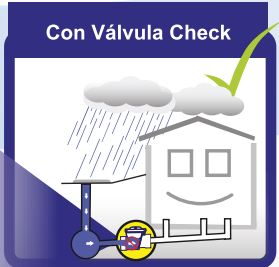

## VÁLVULA CHECK HORIZONTAL 4"

Códigos Medidas

PCP03001 4"

La válvula check Anti-retorno evita la devolución de aguas residuales a su hogar o parqueadero, las cuales retornan a su origen cuando el nivel del agua externa supera al de la descarga. Esta situación es común en viviendas cercanas a los ríos y arroyos o en épocas de lluvia.

### RECOMENDACIONES



NO GOLPEE LA PIEZA



USE LIMPIADOR Y SOLDADURA DE PVC. NO UTILICE ÁCIDOS



NO EXPONGA LAS PIEZAS AL FUEGO



NO APTO PARA AGUA CALIENTE



NO EMPLEE HERRAMIENTAS DE FUERZA PARA LA INSTALACIÓN

- Antes de la instalación, fijese en las flechas que indican el sentido del flujo del agua para que así se haga la instalación.
- Para su funcionamiento se requiere una instalación con una leve pendiente en los sistemas de evacuación y drenajes.
- Se deberá tener fácil acceso a la tapa (parte superior de la válvula), con el fin de poder realizar la limpieza y mantenimiento.
- El cemento solvente, pegamento o soldadura no debe entrar en contacto con la cortina. Se deberá verificar si la cortina tiene libre movimiento.

### DATOS TÉCNICOS

1. Fácil instalación y sin herramientas.
2. No se corroe ni hay desgaste.
3. Excelentes características de flujo.
4. Cuerpo fabricado en PVC de alta resistencia.
5. Aletas de fácil apertura y limpieza.
6. Sus partes internas son de fácil mantenimiento.
7. La válvula check anti-retorno también opera como caja de inspección.
8. Cuenta con nivel como guía en la instalación.

Lisa

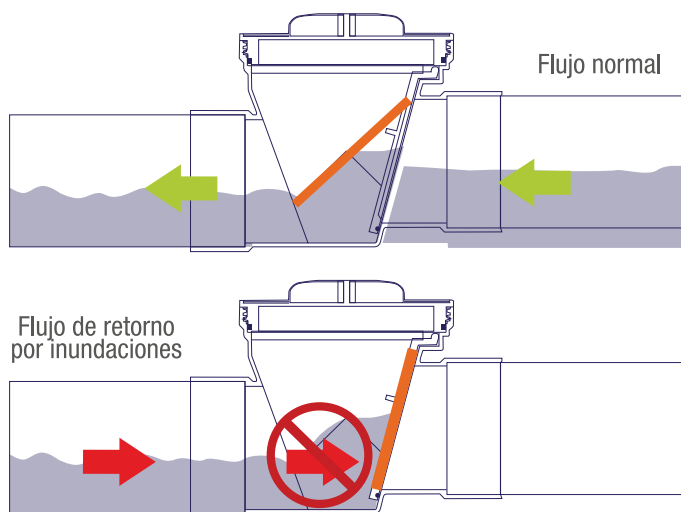

Previene la entrada de



Cucarachas



Roedores



Aguas Lluvias





## LLAVE PARA MANGUERA



Códigos Medidas

PCP02001 1/2" x 1/2"

### DATOS TÉCNICOS

1. Diseño exclusivo con manija larga más resistente y ergonómica que facilita el uso.
2. Alta resistencia a la corrosión y al desgaste.
3. Apertura y cierre rápido de ¼ de giro.
4. Manija con cierre hacia ambos lados para espacios reducidos.
5. Rosca macho de ½" en plástico de ingeniería.
6. Rosca macho tipo jardín en la salida.
7. Fabricado en cuerpo compacto tipo pesado.
8. Excelentes características de flujo.
9. Fácil instalación y sin herramientas.
10. Incluye reductor (OPCIONAL) que ahorra hasta 50%\* en el consumo del agua.
11. Cumple normatividad ASTM D2466.

\* Con el reductor se obtiene un flujo de 9,6 Litros/Minuto. 33 psi. Si requiere mayor flujo de agua retire el reductor. Aplica únicamente para Rosca Macho.

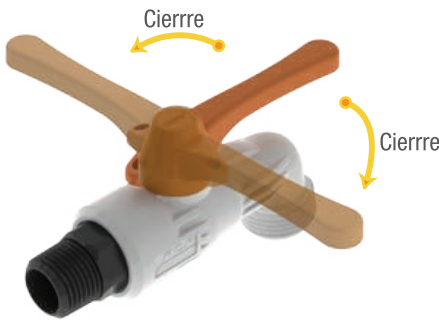

(Inserto Bronce Cromado)

## LLAVE PARA MANGUERA

Códigos Medidas

PCP02001 1/2" x 1/2"

\*Rosca Nylon\*

PCP02011 1/2" x 1/2"

\*Inserto Bronce\*



### Recomendaciones

- NO GOLPEE LA PIEZA
- USE CINTA SELLADORA DE PTFE
- NO EXPONGA LAS PIEZAS AL FUEGO
- NO APTO PARA AGUA CALIENTE
- NO PINTE EL PRODUCTO, LAS PINTURAS PUEDEN CONTENER AGENTES NOCIVOS PARA EL PRODUCTO
- NO EMPLEE HERRAMIENTAS DE FUERZA PARA LA INSTALACIÓN

## LLAVE DE ARRESTO CON MANGUERA PARA LAVAMANOS Y FREGADEROS

Códigos Medidas

PCP04001 1/2"

### DATOS TÉCNICOS

- Fácil instalación y sin herramientas.
- Evita la acumulación de sarro.
- Alta resistencia a la corrosión y al desgaste.
- Resistentes al agua caliente y fría.
- Tuerca de tres aletas.
- Tuercas en Polipropileno (PP).
- El registro de una salida en POM, entrada rosca hembra de 1/2" NPT y salida rosca macho de 1/2" NPT.
- El registro genera un punto de control en las conexiones (cerrar o abrir el paso de agua).
- El registro de derivación es pequeño y cómodo para la instalación.
- Los acoples tienen una presión máxima de trabajo de 125 psi a 23°C.
- El registro mini de una salida tiene una presión máxima de trabajo de 150 psi a 23°C.

## LLAVE DE ARRESTO CON MANGUERA PARA INODORO

Códigos Medidas

PCP04002 7/8"

### DATOS TÉCNICOS

- Fácil instalación y sin herramientas.
- Evita la acumulación de sarro.
- Alta resistencia a la corrosión y al desgaste.
- Resistentes al agua caliente y fría.
- Tuerca de tres aletas.
- Tuercas en Polipropileno (PP).
- El registro de una salida en POM, entrada rosca hembra de 1/2" NPT y salida rosca macho de 1/2" NPT.
- El registro genera un punto de control en las conexiones (cerrar o abrir el paso de agua).
- El registro de derivación es pequeño y cómodo para la instalación.
- Los acoples tienen una presión máxima de trabajo de 125 psi a 23°C.
- El registro mini de una salida tiene una presión máxima de trabajo de 150 psi a 23°C.





# CONEXIONES PVC

SCH40, SCH80, CPVC,  
Drenaje, Riego



[www.fermetal.com.do](http://www.fermetal.com.do)



## Coupling

Código	Medida	Diagrama
FMPVC001	1/2"	
FMPVC002	3/4"	
FMPVC003	1"	
FMPVC004	1-1/2"	
FMPVC005	2"	



## Coupling Reducido

Código	Medida	Diagrama
FMPVC011	3/4" x 1/2"	
FMPVC012	1" x 1/2"	
FMPVC013	1" x 3/4"	



## Tee

Código	Medida	Diagrama
FMPVC061	1/2"	
FMPVC062	3/4"	
FMPVC063	1"	
FMPVC064	1-1/2"	
FMPVC065	2"	



## Codo 90°

Código	Medida	Diagrama
FMPVC021	1/2"	
FMPVC022	3/4"	
FMPVC023	1"	
FMPVC024	1-1/2"	
FMPVC025	2"	



## Codo 45°

Código	Medida	Diagrama
FMPVC051	1/2"	
FMPVC052	3/4"	
FMPVC053	1"	
FMPVC054	1-1/2"	
FMPVC055	2"	
FMPVC056	3"	



## Adaptador Macho x Hembra

Código	Medida	Diagrama
FMPVC041	1/2" x 1/2"	
FMPVC042	3/4" x 3/4"	
FMPVC043	1" x 1"	



## Codo Adaptador Hembra 90°

Código	Medida	Diagrama
FMPVC031	1/2"	
FMPVC032	3/4"	



## Codo Adaptador Macho 90°

Código	Medida	Diagrama
FMPVC211	1/2"	
FMPVC212	3/4"	



## Codo adaptador macho

Código	Medida	Diagrama
FMPVC221	1/2"	
FMPVC222	3/4"	



## Tapa Hembra

Código	Medida	Diagrama
FMPVC071	1/2"	
FMPVC072	3/4"	
FMPVC073	1"	
FMPVC074	1-1/2"	
FMPVC075	2"	

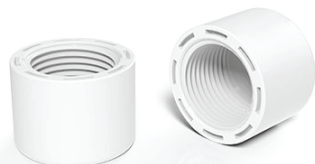

## Tapa Hembra Roscada

Código	Medida	Diagrama
FMPVC081	1/2"	
FMPVC082	3/4"	



## Conexión para Tinaco

Código	Medida	Diagrama
FMPVC201	1/2"	
FMPVC202	3/4"	
FMPVC203	1"	



## Tapón macho con Rosca Cuadrado

Código	Medida	Diagrama
FMPVC341	1/2"	
FMPVC342	3/4"	



## Tapón macho con Rosca Hexagonal

Código	Medida	Diagrama
FMPVC091	1/2"	
FMPVC092	3/4"	



## Reducción

Código	Medida	Diagrama
FMPVC131	3/4" x 1/2"	
FMPVC132	1" x 1/2"	
FMPVC133	1" x 3/4"	
FMPVC136	1-1/2" x 1"	
FMPVC137	2" x 1-1/2"	



Conexión  
Bronce

## Adaptador Hembra

Código	Medida	Diagrama
FMPVC111	1/2"	
FMPVC112	3/4"	

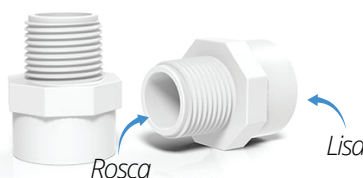

## Adaptador Macho

Código	Medida	Diagrama
FMPVC121	1/2"	
FMPVC122	3/4"	
FMPVC123	1"	
FMPVC124	1-1/2"	
FMPVC125	2"	



## Adaptador Hembra

Código	Medida	Diagrama
FMPVC101	1/2"	
FMPVC102	3/4"	
FMPVC103	1"	
FMPVC104	1-1/2"	
FMPVC105	2"	



## Unión Dresser

Código	Medida	Diagrama
FMPVC151	1/2"	
FMPVC152	3/4"	
FMPVC153	1"	
FMPVC154	1-1/2"	
FMPVC155	2"	
FMPVC156	3"	
FMPVC157	4"	



## Unión Universal

Código	Medida	Diagrama
FMPVC161	1/2"	
FMPVC162	3/4"	
FMPVC163	1"	
FMPVC164	1-1/2"	
FMPVC165	2"	
FMPVC166	3"	
FMPVC167	4"	



## Válvula de Bola

Código	Medida	Diagrama
FMPVC171	1/2"	
FMPVC172	3/4"	
FMPVC173	1"	
FMPVC174	1-1/2"	
FMPVC175	2"	
FMPVC176	3"	



## Válvula de Bola Pesada con Palanca

Código	Medida	Diagrama
FMPVC181	1/2"	
FMPVC182	3/4"	
FMPVC183	1"	



## Válvula de Bola Roscada

Código	Medida	Diagrama
FMPVC191	1/2"	
FMPVC192	3/4"	

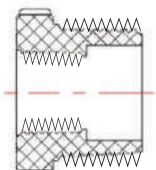

## Reducción con Rosca

Código	Medida	Diagrama
FMPVC361	3/4" x 1/2"	

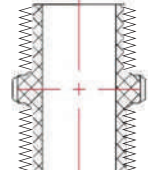
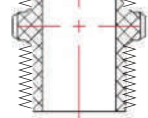

## Niple con Rosca

Código	Medida	Diagrama
FMPVC301	1/2"	
FMPVC302	3/4"	



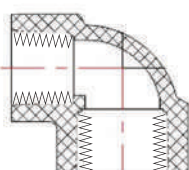
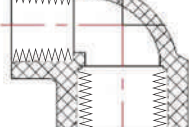

## Codo con Rosca 90°

Código	Medida	Diagrama
FMPVC321	1/2"	
FMPVC322	3/4"	

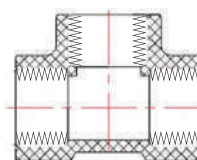

## Tee con Rosca

Código	Medida	Diagrama
FMPVC331	1/2"	
FMPVC332	3/4"	

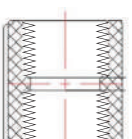
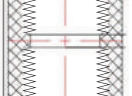

## Coupling con Rosca

Código	Medida	Diagrama
FMPVC311	1/2"	
FMPVC312	3/4"	

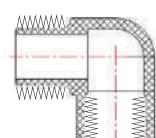

## Codo Niple con Rosca

Código	Medida	Diagrama
FMPVC351	1/2"	



## Tubos de CPVC Agua caliente

Norma	Código	Descripción	Longitud	Diagrama
SDR 11	FMPVC 401	1/2"	10 pies	
SDR 11	FMPVC 402	3/4"	10 pies	



### Coupling

Código	Medida	Diagrama
FMPVC411	1/2"	
FMPVC412	3/4"	



### Codo 90°

Código	Medida	Diagrama
FMPVC421	1/2"	
FMPVC422	3/4"	

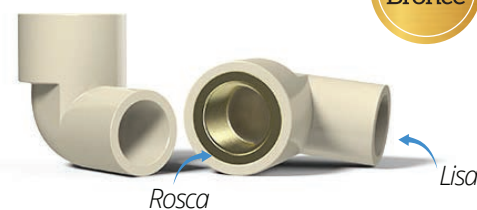

### Codo Adaptador 90° Hembra Bronce

Código	Medida	Diagrama
FMPVC425	1/2" x 1/2"	

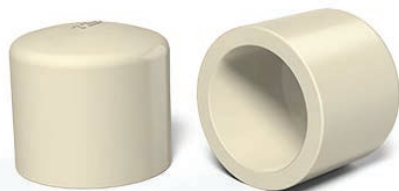

### Tapa

Código	Medida	Diagrama
FMPVC471	1/2"	

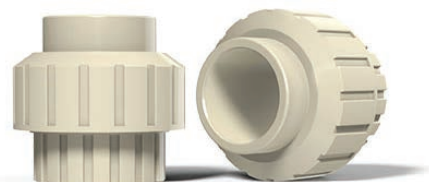

### Union Universal

Código	Medida	Diagrama
FMPVC481	1/2"	



### Válvula

Código	Medida	Diagrama
FMPVC491	1/2"	





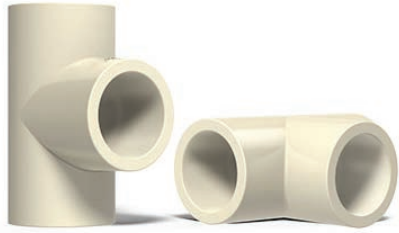

### Tee

Código	Medida	Diagrama
FMPVC431	1/2"	
FMPVC432	3/4"	



### Adaptador Macho con Rosca

Código	Medida	Diagrama
FMPVC441	1/2"	
FMPVC442	3/4"	

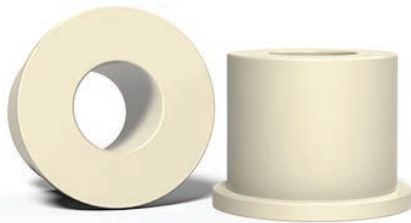

### Bushing

Código	Medida	Diagrama
FMPVC451	3/4" x 1/2"	

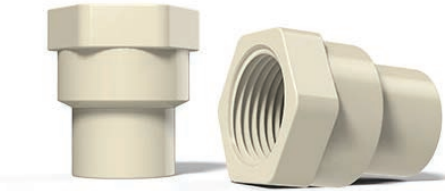

### Adaptador Hembra Rosca

Código	Medida	Diagrama
FMPVC461	1/2"	

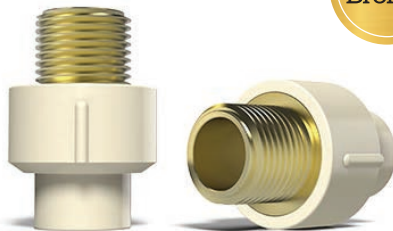

### Adaptador Macho Rosca Bronce

Código	Medida	Diagrama
FMPVC445	1/2"	

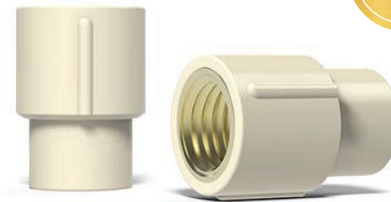

### Coupling con Rosca

Código	Medida	Diagrama
FMPVC465	1/2"	



### Coupling

Código	Medida	Diagrama
FMPVC801	1/2"	
FMPVC802	3/4"	
FMPVC803	1"	
FMPVC804	1-1/2"	
FMPVC805	2"	



### Codo 90°

Código	Medida	Diagrama
FMPVC811	1/2"	
FMPVC812	3/4"	
FMPVC813	1"	
FMPVC814	1-1/2"	
FMPVC815	2"	



### Codo 45°

Código	Medida	Diagrama
FMPVC821	1/2"	



### Tee

Código	Medida	Diagrama
FMPVC831	1/2"	
FMPVC832	3/4"	
FMPVC833	1"	
FMPVC834	1-1/2"	
FMPVC835	2"	



### Adaptador Hembra

Código	Medida	Diagrama
FMPVC841	1/2"	
FMPVC842	3/4"	
FMPVC843	1"	
FMPVC844	1-1/2"	
FMPVC845	2"	



### Adaptador Macho

Código	Medida	Diagrama
FMPVC851	1/2"	
FMPVC852	3/4"	
FMPVC853	1"	
FMPVC854	1-1/2"	
FMPVC855	2"	



### Bushing

Código	Medida	Diagrama
FMPVC861	3/4" x 1/2"	
FMPVC862	1" x 3/4"	
FMPVC864	1-1/2" x 1"	
FMPVC867	2" x 1"	
FMPVC868	2" x 1-1/2"	



### Unión Universal

Código	Medida	Diagrama
FMPVC871	1/2"	
FMPVC872	3/4"	
FMPVC873	1"	
FMPVC874	1-1/2"	
FMPVC875	2"	



Codo 90°



Codo 45°



Tee

Código	Medida	Diagrama
FMPVC501	2"	
FMPVC502	3"	
FMPVC503	4"	

Código	Medida	Diagrama
FMPVC511	2"	
FMPVC512	3"	
FMPVC513	4"	

Código	Medida	Diagrama
FMPVC521	2"	
FMPVC522	3"	
FMPVC523	4"	



Drenaje Yee



Reducción



Registro

Código	Medida	Diagrama
FMPVC531	2"	
FMPVC532	3"	

Código	Medida	Diagrama
FMPVC572	3" x 2"	
FMPVC573	4" x 2"	
FMPVC574	4" x 3"	

Código	Medida	Diagrama
FMPVC551	2"	
FMPVC552	3"	
FMPVC553	4"	



Coupling



Gancho para Tubo

Código	Medida	Diagrama
FMPVC562	3"	
FMPVC563	4"	

Código	Medida	Diagrama
FMPVC542	3"	

# Rejillas Sifonadas



Código	Medida	Diagrama
TUBPL1101	3" x 2"	
TUBPL1102	4" x 3"	

Código	Medida	Diagrama
TUBPL1111	3" x 2"	
TUBPL1112	4" x 3"	

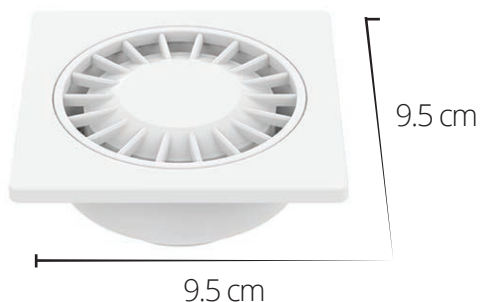

Código	Medida	Diagrama
FMPVC581	Salida: 2" - 3"	

Código	Medida	Diagrama
FMPVC585	Salida: 2" - 3"	

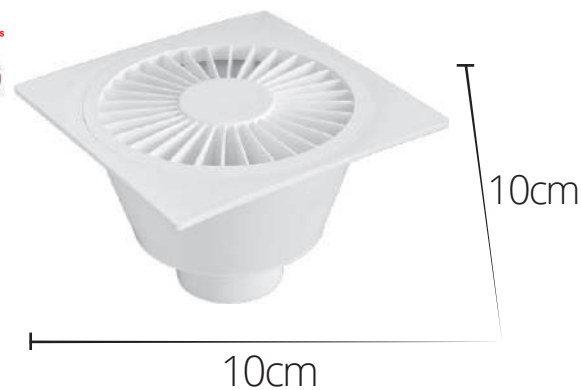

Código	Medida	Diagrama
FMPVC590	Salida: 4"	

Código	Medida	Diagrama
DUR25001	Salida: 1-1/2" - 2" - 3"	



## Coupling

Código	Medida	Diagrama
FMRG0001	20mm	
FMRG0002	25mm	
FMRG0003	32mm	
FMRG0004	40mm	
FMRG0005	50mm	



## Coupling Reductor

Código	Medida	Diagrama
FMRG0011	25x20mm	
FMRG0012	32x20mm	
FMRG0013	32x25mm	
FMRG0014	40x32mm	
FMRG0015	50x32mm	



## Adaptador Macho

Código	Medida	Diagrama
FMRG0021	20mm x 1/2"	
FMRG0022	25mm x 3/4"	
FMRG0023	32mm x 1"	
FMRG0024	40mm x 1"	
FMRG0025	50mm x 1-1/2"	



## Adaptador Hembra

Código	Medida	Diagrama
FMRG0031	20mm x 1/2"	
FMRG0032	25mm x 3/4"	
FMRG0033	32mm x 1"	



## Codo 90°

Código	Medida	Diagrama
FMRG0041	20mm	
FMRG0042	25mm	
FMRG0043	32mm	
FMRG0044	40mm	
FMRG0045	50mm	



## Tee

Código	Medida	Diagrama
FMRG0051	20x20x20mm	
FMRG0052	25x25x25mm	
FMRG0053	32x32x32mm	
FMRG0054	40x40x40mm	
FMRG0055	50x50x50mm	



## Tee reducida

Código	Medida	Diagrama
FMRG0061	25x20x25mm	
FMRG0062	32x20x32mm	
FMRG0063	32x25x32mm	
FMRG0064	40x25x40mm	
FMRG0065	50x32x50mm	



## Tapón

Código	Medida	Diagrama
FMRG0071	20 mm	
FMRG0072	25 mm	
FMRG0073	32 mm	
FMRG0074	40 mm	
FMRG0075	50 mm	





## Válvula

Código	Medida	Diagrama
FMRG0081	20 mm	
FMRG0082	25 mm	
FMRG0083	32 mm	

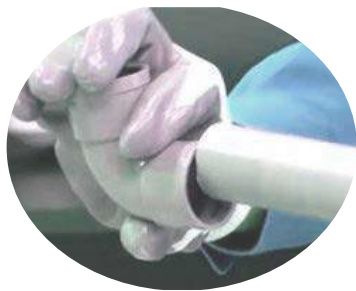
# Pegamentos PVC



Cemento PVC transparente.



Código	Descripción	Bulto	U de M
FM 65 0001	4 onz Sin aplicador	24 piezas	Pieza
FM 65 0002	4 onz Con aplicador 	24 piezas	Pieza
FM 65 0012	8 onz Con aplicador 	24 piezas	Pieza
FM 65 0022	1/4 Galón Con aplicador 	12 piezas	Pieza
FM 65 0025	1 Galón Sin aplicador	4 piezas	Pieza

**¡AZUL  
EXTRA  
FUERTE!**



Cemento PVC azul.



Código	Descripción	Bulto	U de M
FM 65 0032	4 onz Sin aplicador	24 piezas	Pieza
FM 65 0042	8 onz Con aplicador 	24 piezas	Pieza
FM 65 0052	1/4 Galón Con aplicador 	12 piezas	Pieza
FM 65 0055	1 Galón Sin aplicador	4 piezas	Pieza

# Adhesivos para Concreto



¡AZUL  
ALTA  
ADHERENCIA!

Adhesivo para  
concreto

Alta adherencia  
Blue Bond

Código	Descripción	Unidad de medida predeterminada
FM 65 2011	1/4 Galón	1 Caja = 12 piezas
FM 65 2012	1/2 Galón	1 Caja = 9 piezas
FM 65 2013	1 Galón	1 Caja = 6 Galones



Adhesivo para  
concreto  
Bond rosado

Código	Descripción	Unidad de medida predeterminada
FM 65 2001	1/4 Galón	1 Caja = 12 piezas
FM 65 2002	1/2 Galón	1 Caja = 9 piezas
FM 65 2003	1 Galón	1 Caja = 6 Galones



# Conexiones (Fittings) Metálicas

HG(Hierro galvanizado) - SS (Stainless Steel) - Bronce - Níquel

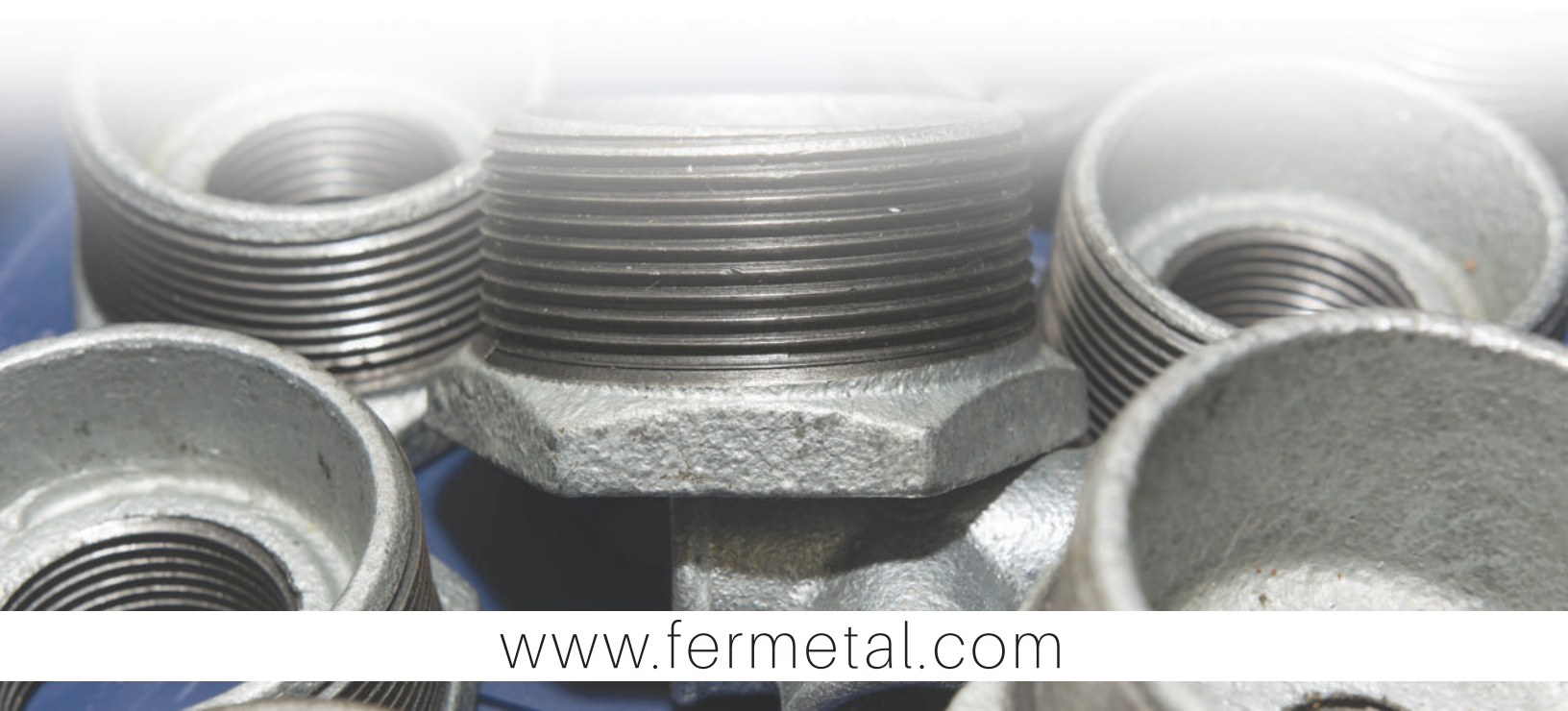

[www.fermetal.com](http://www.fermetal.com)





## Coupling

Código	Descripción	U de M
FTHG 0999	1/4"	Pieza
FTHG 1000	3/8"	Pieza
FTHG 1001	1/2"	Pieza
FTHG 1002	3/4"	Pieza
FTHG 1003	1"	Pieza
FTHG 1005	1 1/2"	Pieza
FTHG 1006	2"	Pieza



## Codo de 90°

Código	Descripción	U de M
FTHG 1009	1/4"	Pieza
FTHG 1010	3/8"	Pieza
FTHG 1011	1/2"	Pieza
FTHG 1012	3/4"	Pieza
FTHG 1013	1"	Pieza
FTHG 1015	1 1/2"	Pieza
FTHG 1016	2"	Pieza
FTHG 1017	3"	Pieza



## Tee

Código	Descripción	U de M
FTHG 1039	1/4"	Pieza
FTHG 1040	3/8"	Pieza
FTHG 1041	1/2"	Pieza
FTHG 1042	3/4"	Pieza
FTHG 1043	1"	Pieza
FTHG 1045	1 1/2"	Pieza
FTHG 1046	2"	Pieza



## Codo de 90° Macho x Hembra

Código	Descripción	U de M
FTHG 1029	1/4"	Pieza
FTHG 1030	3/8"	Pieza
FTHG 1031	1/2"	Pieza
FTHG 1032	3/4"	Pieza
FTHG 1033	1"	Pieza



## Tee reducida

Código	Descripción	U de M
FTHG 1051	3/4" x 1/2"	Pieza



## Codo 90° Reducida

Código	Descripción	U de M
FTHG 1021	3/4" x 1/2" 90°	Pieza



## Tapón Macho

Código	Descripción	U de M
FTHG 1069	1/4"	Pieza
FTHG 1070	3/8"	Pieza
FTHG 1071	1/2"	Pieza
FTHG 1072	3/4"	Pieza
FTHG 1073	1"	Pieza
FTHG 1075	1½"	Pieza
FTHG 1076	2"	Pieza



## Bushing

Código	Descripción	U de M
FTHG 1099	3/8" x 1/4"	Pieza
FTHG 1100	1/2" x 1/4"	Pieza
FTHG 1101	1/2" x 3/8"	Pieza
FTHG 1103	3/4" x 1/2"	Pieza
FTHG 1105	1" x 1/2"	Pieza
FTHG 1107	1" x 3/4"	Pieza
FTHG 1109	1 ¼" x 1"	Pieza
FTHG 1111	1 ½" x 1"	Pieza
FTHG 1115	2" x 1"	Pieza
FTHG 1116	2" x 1½"	Pieza



## Tapa Hembra

Código	Descripción	U de M
FTHG 1079	1/4"	Pieza
FTHG 1080	3/8"	Pieza
FTHG 1081	1/2"	Pieza
FTHG 1082	3/4"	Pieza
FTHG 1083	1"	Pieza
FTHG 1085	1½"	Pieza
FTHG 1086	2"	Pieza



## Coupling de Reducción

Código	Descripción	U de M
FTHG 1061	3/4" x 1/2"	Pieza
FTHG 1062	1" x 1/2"	Pieza
FTHG 1063	1" x 3/4"	Pieza



## Unión Universal

Código	Descripción	U de M
FTHG 1151	1/2"	Pieza
FTHG 1152	3/4"	Pieza
FTHG 1153	1"	Pieza



## Niples



Medida		Código	Referencia
<b>1/4" x</b>	1 ½"	FTHG2010	NIP-16
	2"	FTHG2011	NIP-27
	3"	FTHG2012	NIP-28
	4"	FTHG2013	NIP-29
	5"	FTHG2014	NIP-30
	6"	FTHG2015	NIP-31

<b>3/8" x</b>	1 ½"	FTHG2101	
	2"	FTHG2102	NIP-01
	2 ½"	FTHG2103	NIP-02
	3"	FTHG2104	NIP-03
	4"	FTHG2105	
	5"	FTHG2106	
6"	FTHG2107		

<b>1/2" x</b>	1 ½"	FTHG2202	NIP-11
	2"	FTHG2203	NIP-06
	2 ½"	FTHG2204	NIP-07
	3"	FTHG2205	NIP-08
	4"	FTHG2206	NIP-10
	5"	FTHG2207	NIP-12
	6"	FTHG2208	NIP-13
	8"	FTHG2210	NIP-14
	10"	FTHG2212	NIP-15
12"	FTHG2214	NIP-16	

<b>3/4"</b>	2"	FTHG2303	NIP-17
	2 ½"	FTHG2304	NIP-18
	3"	FTHG2305	NIP-19
	4"	FTHG2306	NIP-20
	5"	FTHG2307	NIP-21
	6"	FTHG2308	NIP-22
	8"	FTHG2309	NIP-23
	10"	FTHG2310	NIP-24
12"	FTHG2311	NIP-25	

Medida		Código	Referencia
<b>1" x</b>	2"	FTHG2403	NIP-32
	3"	FTHG2405	NIP-33
	4"	FTHG2406	NIP-34
	5"	FTHG2407	NIP-35
	6"	FTHG2408	NIP-36

<b>1 ¼" x</b>	3"	FTHG2505	NIP-37
	4"	FTHG2506	NIP-38

<b>1 ½" x</b>	2"	FTHG2605	NIP-39
	3"	FTHG2606	NIP-40
	4"	FTHG0607	NIP-41
	5"	FTHG2608	NIP-42
	6"	FTHG2609	NIP-43

<b>2" x</b>	3"	FTHG2705	NIP-44
	4"	FTHG2706	NIP-45
	5"	FTHG2707	NIP-46
	6"	FTHG2708	NIP-47

<b>3" x</b>	4"	FTHG2806	NIP-48
	5"	FTHG2807	NIP-49
	6"	FTHG2808	NIP-50
	8"	FTHG2809	NIP-51



### Coupling

Código	Descripción	U de M
FTBR 0998	1/4'	Pieza
FTBR 0999	3/8"	Pieza
FTBR 1001	1/2"	Pieza



### Codo de 90°

Código	Descripción	U de M
FTBR 1009	1/4"	Pieza
FTBR 1010	3/8"	Pieza
FTBR 1011	1/2"	Pieza



### Tee

Código	Descripción	U de M
FTBR 1031	1/4"	Pieza
FTBR 1032	3/8"	Pieza
FTBR 1033	1/2"	Pieza



### Codo de 90° Macho x Hembra

Código	Descripción	U de M
FTBR 1021	1/2"	Pieza



### Fitting excentrico Macho x Macho

Código	Descripción	U de M
FTBR 1351	1/2" x 3/4"	Pieza



### Fitting Adaptador Macho x Macho

Código	Descripción	U de M
FTBR 1331	3/4" x 3/4"	Pieza
FTBR 1335	1" x 3/4"	Pieza



### Extensión Hembra x Macho

Código	Descripción	U de M
FTBR 1201	1/2" x 15mm Largo	Pieza
FTBR 1203	1/2" x 20mm Largo	Pieza
FTBR 1204	1/2" x 25mm Largo	Pieza
FTBR 1205	1/2" x 30mm Largo	Pieza



### Bushing

Código	Descripción	U de M
FTBR 1405	3/8" x 1/4"	Pieza
FTBR 1407	1/2" x 1/4"	Pieza
FTBR 1409	1/2" x 3/8"	Pieza
FTBR 1411	3/4" x 1/2"	Pieza
FTBR 1413	1" x 3/4"	Pieza
FTBR 1415	1" x 1/2"	Pieza



### Niple

Código	Descripción	U de M
FTBR 2203	1/2" x 2"	Pieza
FTBR 2204	1/2" x 2 1/2"	Pieza
FTBR 2205	1/2" x 3"	Pieza
FTBR 2103	3/8" x 2"	Pieza
FTBR 2104	3/8" x 2 1/2"	Pieza
FTBR 2105	3/8" x 3"	Pieza



### Coupling

Código	Descripción	U de M
FTNQ 1001	1/2"	Pieza



### Codo de 90°

Código	Descripción	U de M
FTNQ 1011	1/2"	Pieza



### Tee

Código	Descripción	U de M
FTNQ 1021	1/2"	Pieza



### Adaptador Macho x Hembra

Código	Descripción	U de M
FTNQ 1301	3/8" x 3/8"	Pieza
FTNQ 1303	3/8" x 1/2"	Pieza



### Codo de 90° Macho x Hembra

Código	Descripción	U de M
FTNQ 1031	1/2"	Pieza



### Fitting Excéntrico

Código	Descripción	U de M
FTNQ 1311	1/2" x 3/4"	Pieza



### Niple

Código	Descripción	U de M
FTNQ 2103	3/8" x 2"	Pieza
FTNQ 2105	3/8" x 2 1/2"	Pieza
FTNQ 2107	3/8" x 3"	Pieza
FTNQ 2202	1 1/2" x 1 1/2"	Pieza
FTNQ 2203	1/2" x 2"	Pieza
FTNQ 2204	1/2" x 2 1/2"	Pieza
FTNQ 2205	1/2" x 3"	Pieza



### Extensión Hembra x Macho

Código	Descripción	U de M
FTNQ 1201	15mm Largo	Pieza
FTNQ 1203	20mm Largo	Pieza
FTNQ 1204	25mm Largo	Pieza
FTNQ 1205	30mm Largo	Pieza



## Coupling

Código	Descripción	U de M
FTSS 0999	1/4"	Pieza
FTSS 1000	3/8"	Pieza
FTSS 1001	1/2"	Pieza
FTSS 1002	3/4"	Pieza
FTSS 1003	1"	Pieza
FTSS 1005	1½"	Pieza
FTSS 1006	2"	Pieza



## Codo de 90°

Código	Descripción	U de M
FTSS 1009	1/4"	Pieza
FTSS 1010	3/8"	Pieza
FTSS 1011	1/2"	Pieza
FTSS 1012	3/4"	Pieza
FTSS 1013	1"	Pieza
FTSS 1015	1½"	Pieza
FTSS 1016	2"	Pieza



## Tee

Código	Descripción	U de M
FTSS 1030	1/4"	Pieza
FTSS 1031	3/8"	Pieza
FTSS 1032	1/2"	Pieza
FTSS 1033	3/4"	Pieza
FTSS 1034	1"	Pieza
FTSS 1036	1½"	Pieza
FTSS 1037	2"	Pieza



## Bushing

Código	Descripción	U de M
FTSS 1100	3/8" x 1/4"	Pieza
FTSS 1110	1/2" x 3/8"	Pieza
FTSS 1120	3/4" x 1/2"	Pieza
FTSS 1130	1" x 1/2"	Pieza
FTSS 1140	1" x 3/4"	Pieza



## Codo Macho x Hembra

Código	Descripción	U de M
FTSS 1021	1/2"	Pieza





## Niples

Medida		Código
1/4" x	1 1/2"	FTSS2010
	2"	FTSS2011
3/8" x	1 1/2"	FTSS2110
	2"	FTSS2111
	2 1/2"	FTSS2112
	3"	FTSS2113
	4"	FTSS2114
	5"	FTSS2115
	6"	FTSS2116
1/2" x	1 1/2"	FTSS2202
	2"	FTSS2203
	2 1/2"	FTSS2204
	3"	FTSS2205
	4"	FTSS2206
	5"	FTSS2207
	6"	FTSS2208

3/4" x	1 1/2"	FTSS2302
	2"	FTSS2303
	2 1/2"	FTSS2304
	3"	FTSS2305
	4"	FTSS2306
	5"	FTSS2307
1" x	6"	FTSS2308
	1 1/2"	FTSS2402
	2"	FTSS2403
	3"	FTSS2404
	4"	FTSS2405
	5"	FTSS2406
	6"	FTSS2407
1 1/2" x	2"	FTSS2503
	3"	FTSS2505
	4"	FTSS2506
	5"	FTSS2507
	2" x	3"
4"		FTSS2606
5"		FTSS2607
6"		FTSS2608
8"		FTSS2609



Escanea el código



# TUBERIAS Y CONEXIONES PPR

Polipropileno Random



**Certificaciones:** ISO 9001, ISO 14001, OHSAS 18001, HACCP, FW 605 y ISO / TS 16949



[www.fermetal.com.do](http://www.fermetal.com.do)





## Tubos PPR

Para agua fría y agua caliente

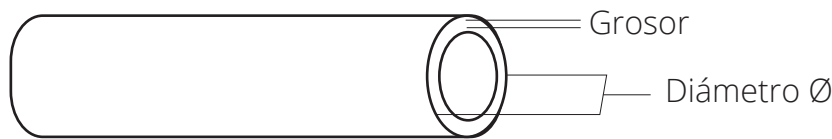

"Todas las medidas son externas"

PN	Código	Grosor	Diámetro (d) Ø	U de M	Tabla de conversión
16	PPR 1 0011	2.8 mm	20mm	4 mts	20mm ≅ 1/2"
16	PPR 1 0012	3.5 mm	25mm	4 mts	25mm ≅ 3/4"
16	PPR 1 0013	4.4 mm	32mm	4 mts	32mm ≅ 1"
16	PPR 1 0014	6.9 mm	50mm	4 mts	50mm ≅ 1½"
16	PPR 1 0015	8.6 mm	63mm	4 mts	63mm ≅ 2"
20	PPR 1 0031	3.4 mm	20mm	4 mts	20mm ≅ 1/2"
20	PPR 1 0032	4.2 mm	25mm	4 mts	25mm ≅ 3/4"



Coupling



Bushing

Código	Diámetro Ø	PN	Diagrama
PPR20001	20 mm	25	
PPR20002	25 mm	25	
PPR20003	32 mm	25	
PPR20004	50 mm	25	
PPR20005	63 mm	25	

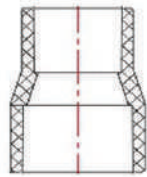
Código	Diámetro Ø	PN	Diagrama
PPR20011	25 - 20 mm	25	
PPR20012	32 - 20 mm	25	
PPR20013	32 - 25 mm	25	
PPR20014	50 - 25 mm	25	
PPR20015	50 - 32 mm	25	
PPR20016	63 - 32 mm	25	
PPR20017	63 - 50 mm	25	

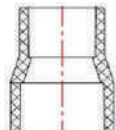

Copa de Reducción

Código	Diámetro Ø	PN	Diagrama
PPR20031	25 - 20mm	25	
PPR20032	32 - 20mm	25	
PPR20033	32 - 25mm	25	

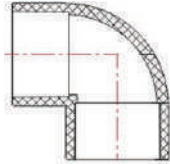

Codo de 90°

Código	Diámetro Ø	PN	Diagrama
PPR20041	20 mm	25	
PPR20042	25 mm	25	
PPR20043	32 mm	25	
PPR20044	50 mm	25	
PPR20045	63 mm	25	



Codo de 45°

Código	Diámetro Ø	PN	Diagrama
PPR20051	20 mm	25	
PPR20052	25 mm	25	
PPR20053	32 mm	25	
PPR20054	50 mm	25	
PPR20055	63 mm	25	



Tee

Código	Diámetro Ø	PN	Diagrama
PPR20061	20 mm	25	
PPR20062	25 mm	25	
PPR20063	32 mm	25	
PPR20064	50 mm	25	
PPR20065	63 mm	25	

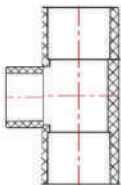

Tee Reducida

Código	Diámetro Ø	PN	Diagrama
PPR20071	25 x 20 x 25 mm	25	
PPR20072	32 x 20 x 32 mm	25	
PPR20073	32 x 25 x 32 mm	25	
PPR20074	50 x 20 x 50 mm	25	
PPR20075	50 x 25 x 50 mm	25	
PPR20076	50 x 32 x 50 mm	25	
PPR20077	63 x 20 x 63 mm	25	
PPR20078	63 x 25 x 63 mm	25	
PPR20079	63 x 32 x 63 mm	25	
PPR20080	63 x 50 x 63 mm	25	



Tapa Hembra

Código	Diámetro Ø	PN	Diagrama
PPR20091	20 mm	25	
PPR20092	25 mm	25	
PPR20093	32 mm	25	
PPR20094	50 mm	25	
PPR20095	63 mm	25	

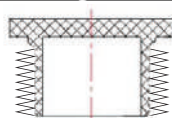

Tapón  
Macho

Código	Diámetro Ø	PN	Diagrama
PPR20101	20 mm	25	
PPR20102	25 mm	25	



Unión  
Universal

Código	Diámetro Ø	PN	Diagrama
PPR20111	20 mm	25	
PPR20112	25 mm	25	
PPR20113	32 mm	25	
PPR20114	50 mm	25	
PPR20115	63 mm	25	

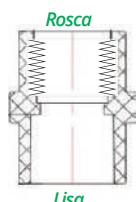

Adaptador  
Hembra

Código	Diámetro Ø	PN	Diagrama
PPR20121	20 mm x 1/2"	25	 <i>Rosca</i> <i>Lisa</i>
PPR20122	25 mm x 3/4"	25	
PPR20123	32 mm x 1"	25	
PPR20124	50 mm x 1 1/2"	25	
PPR20125	63 mm x 2"	25	



Adaptador  
Macho

Código	Diámetro Ø	PN	Diagrama
PPR20141	20 mm x 1/2"	25	 <i>Rosca</i> <i>Lisa</i>
PPR20142	25 mm x 3/4"	25	
PPR20143	32 mm x 1"	25	
PPR20144	50 mm x 1"	25	
PPR20145	63 mm x 2"	25	

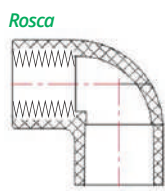

Codo 90°  
Adaptador  
Hembra

Código	Diámetro Ø	PN	Diagrama
PPR20131	20 mm x 1/2"	25	 <i>Rosca</i> <i>Lisa</i>
PPR20132	25 mm x 3/4"	25	
PPR20133	32 mm x 1"	25	



Codo  
Doble para Ducha

Código	Diámetro Ø	PN	Diagrama
PPR20201	20 mm x 1/2"	25	

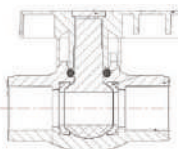

Válvula de bola

Código	Diámetro Ø	PN	Diagrama
PPR20171	20 mm	25	
PPR20172	25 mm	25	
PPR20173	32 mm	25	
PPR20174	50 mm	25	
PPR20175	63 mm	25	

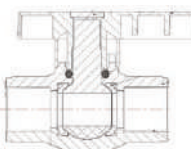

Válvula de bola con unión Doble

Código	Diámetro Ø	PN	Diagrama
PPR20181	20 mm	25	
PPR20182	25 mm	25	



Válvula Cromada

Código	Diámetro Ø	PN	Diagrama
PPR20161	20 mm	25	
PPR20162	25 mm	25	
PPR20163	32 mm	25	

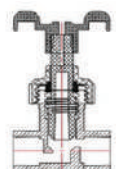

Válvula de cierre

Código	Diámetro Ø	PN	Diagrama
PPR20151	20 mm	25	
PPR20152	25 mm	25	
PPR20153	25 mm	25	



## Kit Maquina de Termofusión

Incluye: Dados de 20/25/32/40mm  
(Tijera Corta Tubos) (Cinta Métrica de 2mts) (Nivel)

Código	Diámetro Ø
PPR30021	<b>20 - 63 mm</b>



### Tijeras Corta Tubos Manual

Código	Diámetro Ø
PPR30001	<b>12 - 40 mm</b>



### Maquina de Termofusión

Código	Descripción
PPR30020	<b>NO INCLUYE DADOS</b>



### Dados

Código	Descripción
PPR30901	<b>20 mm</b>
PPR30902	<b>25 mm</b>
PPR30903	<b>32 mm</b>
PPR30905	<b>50 mm</b>
PPR30906	<b>63 mm</b>



# CONVIERTETE EN NUESTRA IMAGEN FERMETAL

## CON NUESTRO EXHIBIDOR PPR - PEX



Código: EXH20001  
**EXHIBIDOR 2 CARAS**  
40 cm ancho x 250 cm Alto  
**TUBERIAS PPR Y PEX**



# TUBERIAS Y CONEXIONES PEP Polietileno



[www.fermetal.com](http://www.fermetal.com)



## Tubos de Polietileno PEP Agua y Gas

Alta densidad - color negro

Código	Descripción	U de M
TM 81 0012	12 mm x e: 2 mm	Rollo 100m / 328ft
TM 81 0015	15 mm x e: 2,5 mm	Rollo 100m / 328ft
TM 81 0018	18 mm x e: 2,5mm	Rollo 100m / 328ft
TM 81 0022	22 mm x e: 3 mm	Rollo 100m / 328ft
TM 81 0032	32 mm x e: 3 mm	Rollo 50m / 165ft

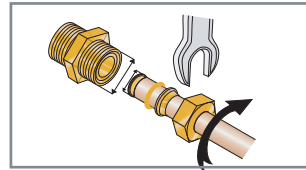
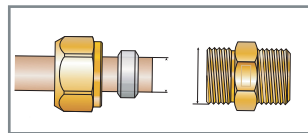
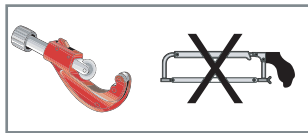

## Racor recto PEP X Macho NPT

Compresión x macho NPT

Código	Descripción
TM 82 0301	12 mm x 3/8"
TM 82 0302	12 mm x 1/2"
TM 82 0303	15 mm x 3/8"
TM 82 0304	15 mm x 1/2"
TM 82 0305	15 mm x 3/4"
TM 82 0306	18 mm x 1/2"
TM 82 0307	18 mm x 3/4"
TM 82 0308	22 mm x 1/2"
TM 82 0309	22 mm x 3/4"



## Racor recto PEP X HEMBRA NPT

Compresión x hembra NPT

Código	Descripción
TM 82 0201	12 mm x 3/8"
TM 82 0202	12 mm x 1/2"
TM 82 0203	15 mm x 3/8"
TM 82 0204	15 mm x 1/2"
TM 82 0205	15 mm x 3/4"
TM 82 0206	18 mm x 1/2"
TM 82 0207	18 mm x 3/4"
TM 82 0208	22 mm x 1/2"
TM 82 0209	22 mm x 3/4"
TM 82 0210	22 mm x 1"

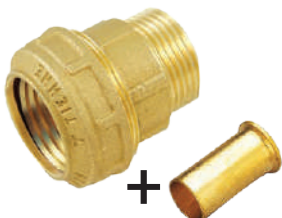

TM 82 0310	25mm x 3/4"
TM 82 0311	32mm x 1"



TM 82 0211	25mm x 3/4"
TM 82 0212	32mm x 1"



## Racor codo 90° PEP X Macho NPT

*Compresión x macho NPT*



Código	Descripción
TM 82 0601	12 mm x 1/2"
TM 82 0602	15 mm x 1/2"
TM 82 0603	15 mm x 3/4"
TM 82 0604	18 mm x 1/2"
TM 82 0605	18 mm x 3/4"
TM 82 0606	22 mm x 3/4"

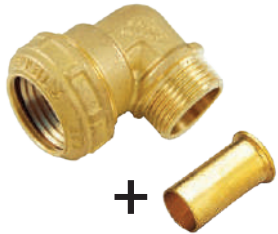

TM 82 0607	25mm x 3/4"
TM 82 0608	32mm x 1"

## Racor codo 90° PEP X Hembra NPT

*Compresión x hembra NPT*



Código	Descripción
TM 82 0501	12 mm x 1/2"
TM 82 0502	15 mm x 1/2"
TM 82 0503	15 mm x 3/4"
TM 82 0504	18 mm x 1/2"
TM 82 0505	18 mm x 3/4"
TM 82 0506	22 mm x 1/2"
TM 82 0507	22 mm x 3/4"

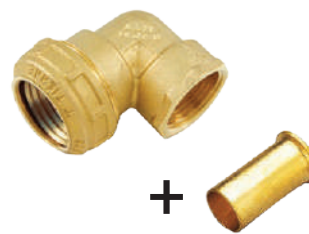

TM 82 0508	25mm x 3/4"
TM 82 0509	32mm x 1"

## Racor recto PEP X PEP

*Compresión x compresión*



Código	Descripción
TM 82 0101	12 mm x 12 mm
TM 82 0102	15 mm x 15 mm
TM 82 0103	18mm x 18 mm
TM 82 0104	22 mm x 22 mm

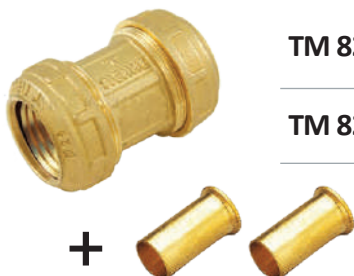

TM 82 0105	25mm x 25 mm
TM 82 0106	32mm x 32 mm

## Racor Tee PEP X PEP X PEP

*Compresión x Compresión x Compresión*



Código	Descripción
TM 82 0701	12 mm
TM 82 0702	15 mm
TM 82 0703	18mm
TM 82 0704	22 mm



TM 82 0705	25mm
TM 82 0706	32mm



**Racor Tee**  
**PEP x MACHO NPT x PEP**

*Compresión x Macho NPT x compresión*



**Racor Tee**  
**PEP x HEMBRA NPT x PEP**

*Compresión x hembra NPT x compresión*

Código	Descripción	U de M
<b>TM 82 0901</b>	15 mm x 1/2" x 15 mm	Pieza
<b>TM 82 0902</b>	18 mm x 1/2" x 18 mm	Pieza
<b>TM 82 0903</b>	22 mm x 3/4" x 22 mm	Pieza

Código	Descripción	U de M
<b>TM 82 0801</b>	12mm x 1/2" x 12mm	Pieza
<b>TM 82 0802</b>	15mm x 1/2" x 15mm	Pieza
<b>TM 82 0803</b>	18mm x 1/2" x 18mm	Pieza
<b>TM 82 0804</b>	22mm x 3/4" x 22mm	Pieza



**Codo 90° PEP X PEP**

*Compresión x compresión*



**Inserto de manguera**  
*e: 3.0 mm*

Código	Descripción	U de M
<b>TM 82 0401</b>	15 mm x 15 mm	Pieza
<b>TM 82 0402</b>	18 mm x 18 mm	Pieza
<b>TM 82 0403</b>	22 mm x 22 mm	Pieza

Código	Descripción
<b>TM 82 9005</b>	25 mm
<b>TM 82 9006</b>	32mm



**Colector entrada 3/4"**

Código	Descripción	U de M
<b>TM 83 1001</b>	Colector entrada 3/4", 2 salidas 1/2" M	Pieza
<b>TM 83 1002</b>	Colector entrada 3/4", 3 salidas 1/2" M	Pieza
<b>TM 83 1003</b>	Colector entrada 3/4", 4 salidas 1/2" M	Pieza
<b>TM 83 1004</b>	Colector entrada 3/4", 5 salidas 1/2" M	Pieza



**Colector entrada 3/4" con valvulas**

Código	Descripción	U de M
<b>TM 83 1011</b>	Colector 3/4", 2 salidas 1/2" M C/ Valvulas	Pieza
<b>TM 83 1012</b>	Colector 3/4", 3 salidas 1/2" M C/ Valvulas	Pieza
<b>TM 83 1013</b>	Colector 3/4", 4 salidas 1/2" M C/ Valvulas	Pieza



**Tapa Hembra Bronce**

Codice	Descripción	U de M
<b>TM 83 2001</b>	1/2"	Pieza
<b>TM 83 2002</b>	3/4"	Pieza
<b>TM 83 2003</b>	1"	Pieza

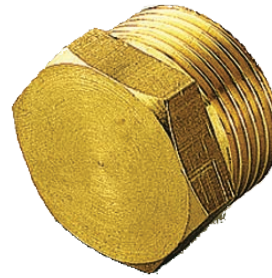

**Tapón Macho Bronce**

Codice	Descripción	U de M
<b>TM 83 2011</b>	1/2"	Pieza
<b>TM 83 2012</b>	3/4"	Pieza
<b>TM 83 2013</b>	1"	Pieza



**Tijera para cortar tubos**

Código	Descripción	U de M
<b>TM 83 2021</b>	Tijera para cortar tubos	Pieza



**Caja para Colector**

Código	Descripción	U de M
<b>TM 83 3001</b>	32 cm x 28 cm	Pieza
<b>TM 83 3002</b>	42 cm x 30 cm	Pieza
<b>TM 83 3003</b>	52 cm x 32 cm	Pieza



# Sistemas de Bombeo



[www.fermetal.com](http://www.fermetal.com)

## Periféricas e Hidrocompactos

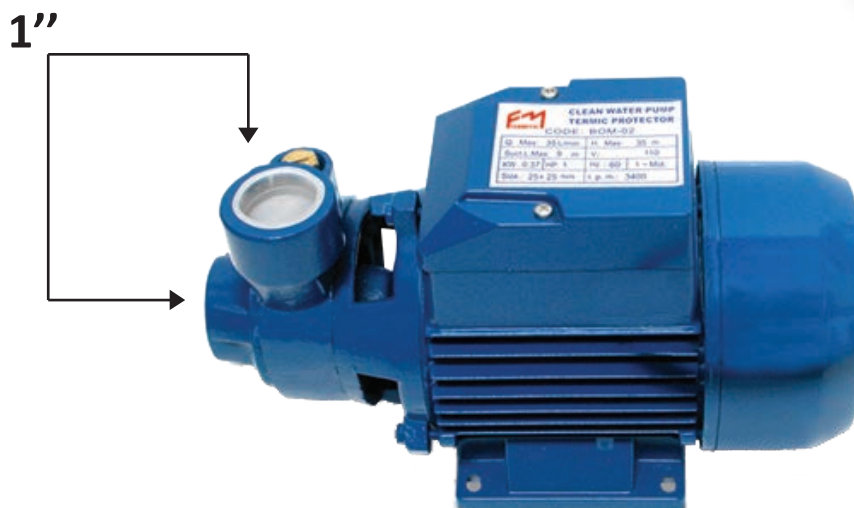

### Bombas periféricas

Código	REF	Potencia	Rendimiento	Caudal max	Succión max	Altura manométrica
FM 70 0001	BOM-02	1/2 HP	370 w	35 Litros	9 m	35 m
FM 70 0002	BOM-03	3/4 HP	550 w	40 Litros	9 m	40 m
FM 70 0003	BOM-04	1 HP	750 w	50 Litros	9 m	50 m



Bomba hidrocompacto 1/2 HP

Código	REF	Descripción
FM 70 0011	BOM-05	Rendimiento: 370w. Caudal max: 35L Succión max: 9m



Bomba hidrocompacto de 1/2 HP

Código	REF	Descripción
FM 70 0012	BOM-08	Rendimiento: 370w Caudal max: 35L Succión max: 9m

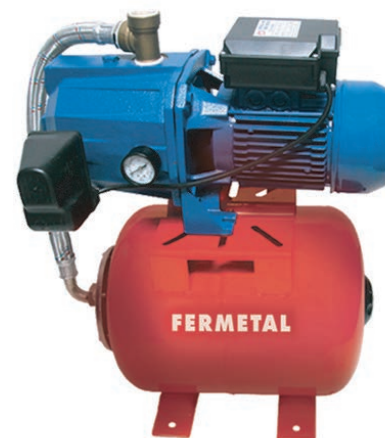

Bomba hidrocompacto de 1 HP

Código	REF	Descripción
FM 70 0021	BOM-06	Rendimiento: 750w. Caudal max: 60L Succión max: 9m



## Centrifugas y Autocebantes



### Bombas Centrifugas

Código	MODELO	Motor	Consumo	Caudal max	Altura manométrica	Entrada y salida
FM 70 0203	BOM-18	3/4 HP	0.5 KW	21 Galones / Minuto	24 mts	1" x 1"
FM 70 0205	BOM-07	1 HP	0.75KW	28 Galones / Minuto	32 mts	1" x 1"
FM 70 0207	BOM-19	2 HP	1.5 KW	105 Galones / Minuto	16 mts	2" x 2"
FM 70 0209	BOM-20	3 HP	2.2 KW	132 Galones / Minuto	17 mts	3" x 3"

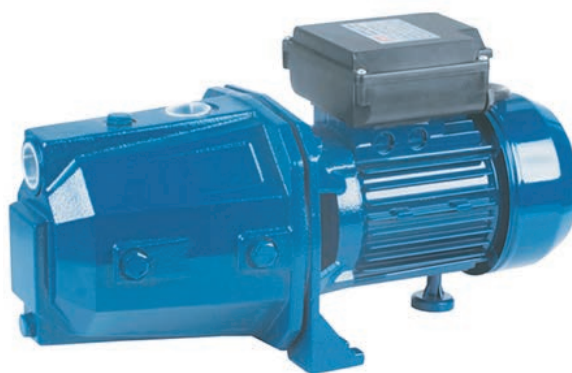

### Bombas autocebantes

Código	REF	Motor	Consumo	Caudal max	Altura manométrica	Entrada y salida
FM 70 0105	BOM- 09	1 HP	0.75KW	16 Galones / Minuto	48 mts	1" x 1"
FM 70 0107	BOM- 11	1.5 HP	1.1 KW	16 Galones / Minuto	48 mts	1" x 1"
FM 70 0109	BOM- 12	2 HP	1.5 KW	19 Galones / Minuto	55 mts	1" x 1"

## Bombas sumergibles

Ancho	Salida
4"	1½"



Motor:	Codigo:	REF:	Consumo:
<b>1/2 HP</b>	FM 70 0303	BOM-30	<b>110V</b>
	FM 70 0351	BOM-30 220V	<b>220V</b>

Caudal (Galones/Minuto)	2.2	4.4	6.6	8.8	11	13.2
Altura	38 mts	36 mts	35 mts	33 mts	30 mts	26 mts

Motor:	Codigo:	REF:	Consumo:
<b>3/4 HP</b>	FM 70 0303	BOM-30	<b>110V</b>
	FM 70 0351	BOM-30 220V	<b>220V</b>

Caudal (Galones/Minuto)	2.2	4.4	6.6	8.8	11	13.2
Altura	58 mts	55 mts	53 mts	50 mts	45 mts	40 mts

Motor:	Codigo:	REF:	Consumo:
<b>1 HP</b>	FM 70 0305	BOM-31	<b>110V</b>
	FM 70 0352	BOM-31 220V	<b>220V</b>

Caudal (Galones/Minuto)	2.2	4.4	6.6	8.8	11	13.2
Altura	80 mts	77 mts	74 mts	70 mts	60 mts	53 mts

Motor:	Codigo:	REF:	Consumo:
<b>1.5 HP</b>	FM 70 0307	BOM-32	<b>110V</b>
	FM 70 0353	BOM-32 220V	<b>220V</b>

Caudal (Galones/Minuto)	2.2	4.4	6.6	8.8	11	13.2
Altura	110mts	105mts	100mts	95 mts	85 mts	67 mts

Motor:	Codigo:	REF:	Consumo:
<b>2 HP</b>	FM 70 0309	BOM-33	<b>110V</b>
	FM 70 0355	BOM-33 220V	<b>220V</b>

Caudal (Galones/Minuto)	2.2	4.4	6.6	8.8	11	13.2
Altura	130	125mts	120mts	115mts	100mts	88mts



Incluye caja de control



### Switch de Presión

Código	REF	Descripción
<b>FM 70 9123</b>	REP-01015	Switch de presión



### Manómetro

Código	REF	Descripción
<b>FM 70 9122</b>	REP-01016	Manometro de repuesto



Contacto de Cobre



### Switch Automático de Presión

Código	REF	Descripción
<b>FM 70 9141</b>	PSC-01	Para Hidrocompactos



Contacto de Plata



### Switch automático de Presión

Código	REF	Descripción
<b>FM 70 9142</b>	PSC-02	Para Hidrocompactos



### Caja de Control

### Caja de Control para Bombas Sumergibles

Código	Voltaje	Descripción
<b>FM 70 0401</b>	110V	1/2 HP -
<b>FM 70 0402</b>	110V	3/4 HP 550W
<b>FM 70 0403</b>	110V	1 HP 750W
<b>FM 70 0404</b>	110V	1.5 HP 1100W
<b>FM 70 0405</b>	110V	2 HP 1500W
<b>FM 70 0412</b>	220V	3/4HP 550W
<b>FM 70 0413</b>	220V	1 HP 750W
<b>FM 70 0414</b>	220V	1.5 HP 1100W
<b>FM 70 0415</b>	220V	2 HP 1500W







## Impeler

Código	REF	Descripción
FM 70 9002	REP-01001	Impeler para <b>BOM-02</b>
FM 70 9012	REP-01006	Impeler para <b>BOM-03/04</b>



## Tee 5 vías (Bronce)

Código	REF	Descripción
FM 70 9121	REP-01018	Tee de 5 vías para hidrocompactos



## KIT-13

Código	REF	Descripción
FM 70 9111	KIT-13	Kit para hidrocompactos de 5L



## KIT-14

Código	REF	Descripción
FM 70 9112	KIT-14	Kit para hidrocompactos de 24L



## KIT-16

Código	REF	Descripción
FM 70 9101	KIT-16	Tanque de 24L para BOM-06 /08



## KIT-12

Código	REF	Descripción
FM 70 9110	KIT-12	KIT: Manometro, tee de 5 vías y switch de presión



## Tanque de 2lts (Para BOM-05)

Código	REF	Descripción
FM 70 9100	BOM-05 TANQUE	Tanque de 2 litros



## Manguera para tanque

Código	REF	Descripción
FM 70 9124	REP-01026	Manguera 1" para tanque 24L para <b>BOM-06/08</b>



## Capacitor

Código	REF	Descripción
<b>FM 70 9001</b>	REP-01000	Capacitor de <b>25 mf</b> para <b>BOM-02</b>
<b>FM 70 9011</b>	REP-01005	Capacitor de <b>40 mf</b> para <b>BOM-03/04</b>



## Aspa plástica

Código	REF	Descripción
<b>FM 70 9021</b>	REP-01009	Aspa plástica para <b>BOM-03/04</b>
<b>FM 70 9007</b>	REP-01044	Aspa plástica para <b>BOM-02</b>



## Tapa superior

Código	REF	Descripción
<b>FM 70 9005</b>	REP-01004	Tapa superior para <b>BOM-02</b>
<b>FM 70 9014</b>	REP-01008	Tapa superior para <b>BOM-03/04</b>



## Tapa trasera

Código	REF	Descripción
<b>FM 70 9022</b>	REP-01042	Tapa trasera para <b>BOM-03/04</b>
<b>FM 70 9006</b>	REP-01043	Tapa trasera para <b>BOM-02</b>



## Rodamiento 6201 / 6202

Código	REF	Descripción
<b>FM 70 9003</b>	REP-01002	Rodamiento 6201 para <b>BOM-02/05/08</b>
<b>FM 70 9013</b>	REP-01007	Rodamiento 6202 para <b>BOM-03/04/06</b>



## Sello

Código	REF	Descripción
<b>FM 70 9004</b>	REP-01003	Sello para <b>BOM-02</b>
<b>FM 70 9015</b>	REP-01032	Sello para <b>BOM-03/04</b>

# DURÍN®



## Accesorios y Conexiones



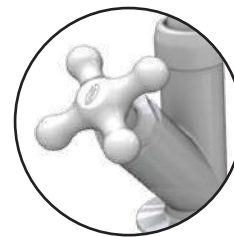

## Cuello Cisne

Color	Código	REF	Descripción
Blanco	DUR11030	01000	1/2"



## Manilla Cruz

Color	Código	REF	Descripción
Blanco	DUR11010	00656	1/2"
Blanca Cromada	DUR11012	00637	1/2"

DUR11010

DUR11012



## Manilla Palanca

Color	Código	REF	Descripción
Blanca	DUR11000	00652	1/2"
Blanca Cromada	DUR11002	00625	1/2"
Negra	DUR11003	00633	1/2"

DUR11000

DUR11002

DUR11003



## Cuello Cisne

Color	Código	REF	Descripción
Blanco	DUR12020	01146	1/2"



DUR12010

DUR12012

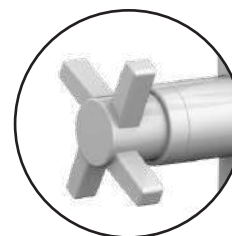

## Manilla Cruz

Color	Código	REF	Descripción
Blanco	DUR12010	00655	1/2"
Blanca Cromada	DUR12012	00636	1/2"



DUR12000

DUR12002

DUR12003

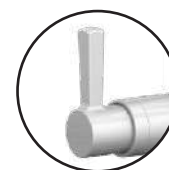

## Manilla Palanca

Color	Código	REF	Descripción
Blanca	DUR12000	00651	1/2"
Blanca Cromada	DUR12002	00624	1/2"
Negra	DUR12003	00632	1/2"



Color	Código	REF	Descripción
Blanco	DUR14002	01534	1/2"



Color	Código	REF	Descripción
Negro	DUR14003	01533	1/2"



Color	Código	REF	Descripción
Blanco	DUR14022	01021	1/2"



Color	Código	REF	Descripción
Blanco	DUR14031	11671	1/2"



Juego Accesorios de Baño

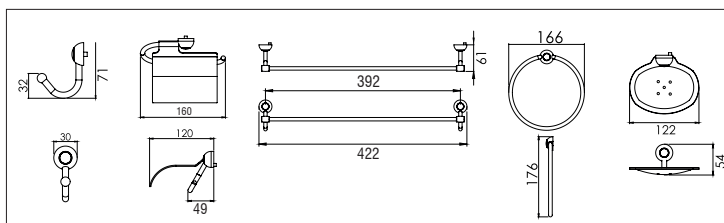

Diagrama

Color	Código	REF	Descripción
Blanco	DUR32003	00555	5 Piezas



Color	Código	REF	Descripción
Blanco	DUR32021	15037	Jabonera ABS

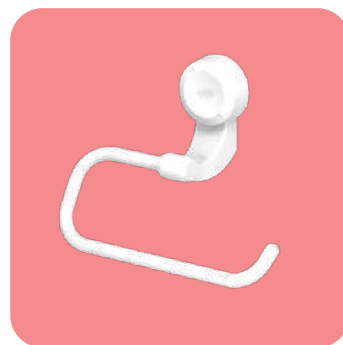

Color	Código	REF	Descripción
Blanco	DUR32022	15031	Porta Papel



Color	Código	REF	Descripción
Blanco	DUR32023	15034	Porta Toalla

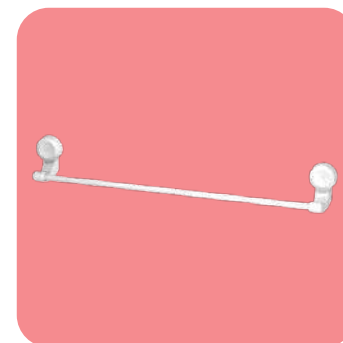

Color	Código	REF	Descripción
Blanco	DUR32024	15231	Barra Porta Toalla



Kit de Lavamanos

Color	Código	REF	Descripción
Blanco	DUR33101	00605	Incluye acc.



Incluye estos accesorios



Lavadero Plastico 24 Litros  
26" X 19" X 14"

Color	Código	REF	Descripción
Blanco	DUR33111	00343	Incluye acc.

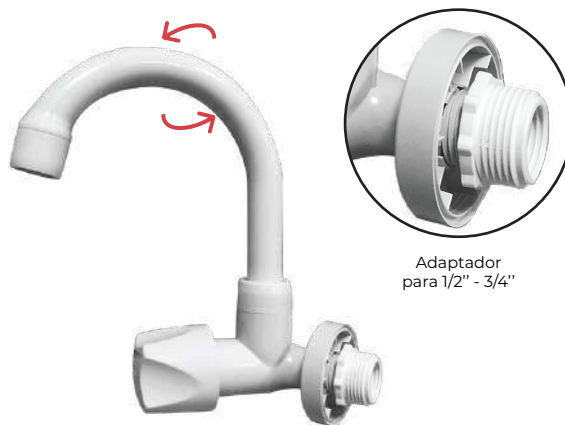

Adaptador  
para 1/2" - 3/4"

Griferia multiusos para  
Lavadero 1/2" - 3/4"

Color	Código	REF	Descripción
Blanco	DUR18000	01050	Incluye adaptador



Tapón para Lavadero

Color	Código	REF	Descripción
Blanco	DUR33119	00331	-



Llave lavadero Tipo Floron  
15 cm 1/2" - 3/4"

Color	Código	REF	Descripción
Blanco	DUR18002	01075	Incluye adaptador



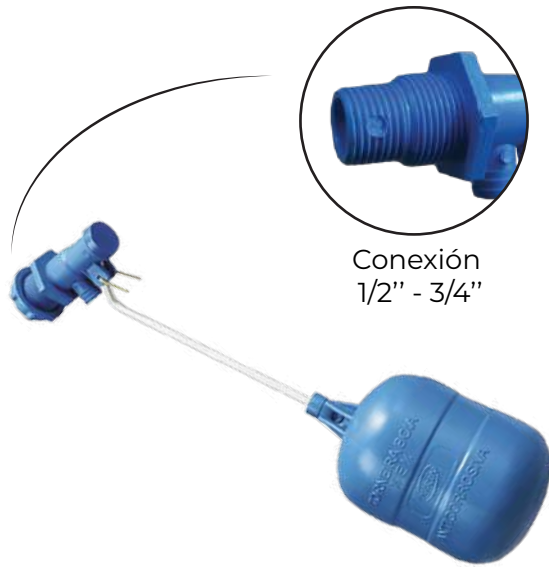

Conexión  
1/2" - 3/4"

### Válvula para tinaco

Color	Código	REF	Descripción
Blanco	DUR28012	00210	Adaptador 1/2" - 3/4"



### Conexión para tinaco

Código	REF	Descripción
DUR28021	00400	1/2"
DUR28022	00401	3/4"
DUR28023	00402	1"



### Sifón extensible

Código	REF	Descripción
DUR21102	00309	150 cm



### Sifón extensible doble

Código	REF	Descripción
DUR21103	00340	Doble



### Rejilla Sifonada

Código	REF	Descripción
DUR25001	00321	1 1/2" - 2" - 3"



Filtro de agua Hembra  
Bronce

Código	REF	Descripción
DUR51001	00378	3/4"



Filtro de agua Para Fregadero

Código	REF	Descripción
DUR51011	00223	Blanco 1/2"



Adaptador  
para 1/2" - 3/4"

Filtro de agua para  
Pared

Código	REF	Descripción
DUR51021	01083	1/2" - 3/4"

## Repuestos



Repuesto para Filtro de agua  
de 3/4"

Código	REF	Descripción
DUR51101	00316	Para DUR51001



Repuesto para Filtro de agua  
de 3/4"

Código	REF	Descripción
DUR51102	01098	DUR510011 / 021

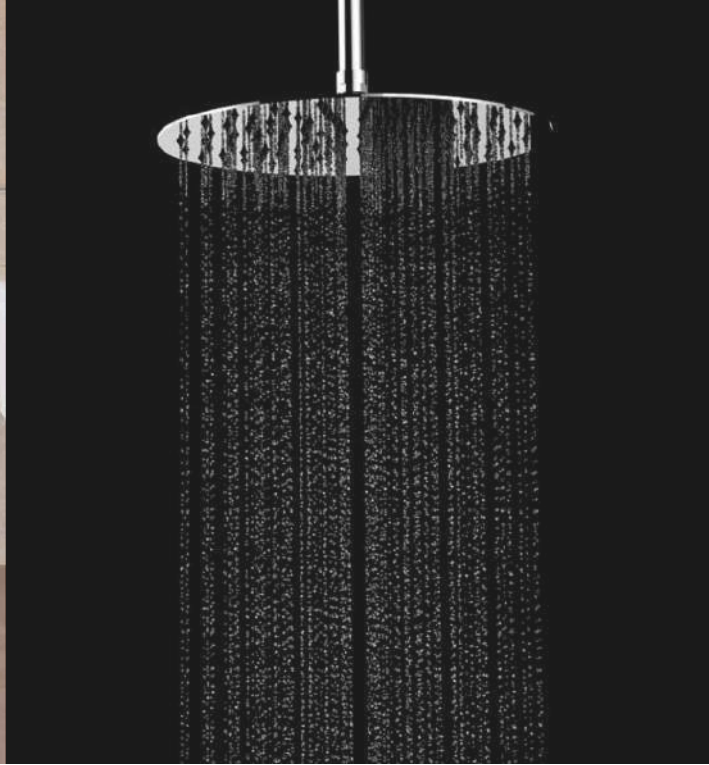

unique



Calidad para tu hogar



Código: UQ101020

**GRI-610**

Monomando para fregadero,  
Acabado Cromado



Código: UQ101901  
**REP-220**

Repuesto de regadera  
para GRI-600



Código: UQ101021

**GRI-611**

Monomando Alto para fregadero,  
vástago sedal.



Código: UQ 10 1001

**GRI-600**

Monomando para fregadero,  
vástago sedal.





Código: UQ101101

**GRI-613**

Grifería para fregadero  
Acabado Cromado.



Vástago Cerámico  
**REP-222**



Código: UQ101100

**GRI-612**

Grifería para fregadero



Vástago Cerámico  
**REP-221**



Código: UQ101102

**GRI-614**

Grifería para fregadero  
Acabado Satinada.



Vástago Cerámico  
**REP-222**



Códigos:

- UQ 30 1011 REG- 100 8"
- UQ 30 1012 REG- 101 10"
- UQ 30 1013 REG- 102 16"

Regadera metálica cuadrada.  
Ultra delgada.



Códigos:

- UQ 30 1001 REG- 120 8"
- UQ 30 1002 REG- 121 10"
- UQ 30 1003 REG- 122 16"

Regadera metálica redonda.  
Ultra delgada.



Código: UQ 30 2011  
BRA-100

Brazo de techo metálico cuadrado 4".



Código: UQ 30 2001  
BRA-102

Brazo de techo metálico redondo 4".

acero  
inoxidable



Códigos:

UQ 40 2001	REJ- 522	12"
UQ 40 2002	REJ- 523	18"
UQ 40 2003	REJ- 500	24"
UQ 40 2005	REJ- 520	28"

Rejilla rectangular perforada,  
salida de 2"



Códigos:

UQ 40 2011	REJ- 524	12"
UQ 40 2012	REJ- 525	18"
UQ 40 2013	REJ- 501	24"
UQ 40 2015	REJ- 521	28"

Rejilla rectangular estriada,  
salida de 2"

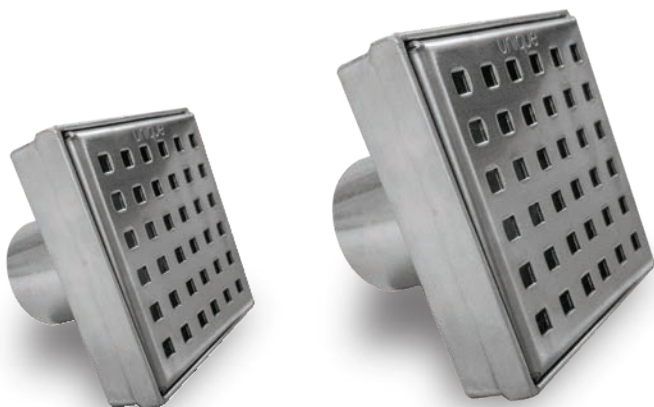

Códigos:

UQ 40 2103	REJ- 526	4x4"
UQ 40 2105	REJ- 527	6x6"

Rejilla cuadrada

• Todas las rejillas traen boquilla de desagüe 

• Todas las rejillas traen el sistema Anti-Cucarachas 



LINEA OVALADA



Código: UQ 40 1011  
**ACC-200**  
Jabonera de Acero inoxidable.



Código: UQ 40 1012  
**ACC-201**  
Perchero de Acero inoxidable.



Código: UQ 40 1013  
**ACC-202**  
Portapapel de Acero inoxidable.



Código: UQ 40 1014  
**ACC-203**  
Portatoallero de Acero inoxidable.



Código: UQ 40 1015  
**ACC-204**  
portatoallero de Acero inoxidable.

BRONCE CROMADO

LINEA CUADRADA

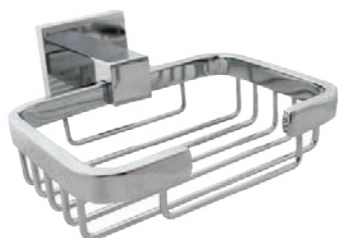

Código: UQ 40 1021  
**ACC-300**  
Jabonera de Acero inoxidable.



Código: UQ 40 1022  
**ACC-301**  
Perchero de Acero inoxidable.



Código: UQ 40 1023  
**ACC-302**  
Portapapel de Acero inoxidable.



Código: UQ 40 1024  
**ACC-303**  
Portatoallero de Acero inoxidable.



Código: UQ 40 1025  
**ACC-304**  
Portatoallero de Acero inoxidable.

BRONCE CROMADO





**LINEA ACERO INOXIDABLE**

[www.fermetal.com.do](http://www.fermetal.com.do)



# GRIFERIAS PARA FREGADERO



Vástago Cerámico  
REP-223



## GRIFERIA PARA FREGADERO 8"

Código	REF	Descripción
FMSS0050	INOX-11	Acabado Satinado



Cartucho Cerámico 35mm  
REP-218



## GRIFERIA PARA FREGADERO DE 1 VIA

Código	REF	Descripción
FMSS0070	INOX-31	Acabado Satinado

# LLAVES PARA FREGADEROS Y LAVAMANOS



Vástago Cerámico  
REP-225

Código	REF	Descripción
-	INOX-01	Llaves para Fregadero 1 vía



Vástago Cerámico  
REP-225

Código	REF	Descripción
-	INOX-02	Llaves para Fregadero 1 vía



Vástago Cerámico  
REP-225

## LLAVES PARA LAVAMANOS

Código	REF	Descripción
-	INOX-101	1 vía

FABRICADAS CON ACERO INOXIDABLE 304

**2** años  
de Garantía



# MONOMANDOS PARA DUCHA Y LAVAMANOS



Cartucho Cerámico 35mm  
REP-218



## MONOMANDO LAVAMANOS

Código	REF	Descripción
-	INOX-121	-



Cartucho Cerámico 35mm  
REP-218



Incluye regadera  
y mangueras



## MONOMANDO DUCHA

Código	REF	Descripción
-	INOX-125	-

FABRICADAS CON ACERO INOXIDABLE 304

2 años  
de Garantía



Cartucho Cerámico 35mm  
REP-218

## MONOMANDO LAVAMANOS

Código	REF	Descripción
-	INOX-131	Monomando <b>Bajo</b>
-	INOX-133	Monomando <b>Alto</b>



Cartucho Cerámico 35mm  
REP-218

## MONOMANDO DUCHA

Código	REF	Descripción
-	INOX-135	-

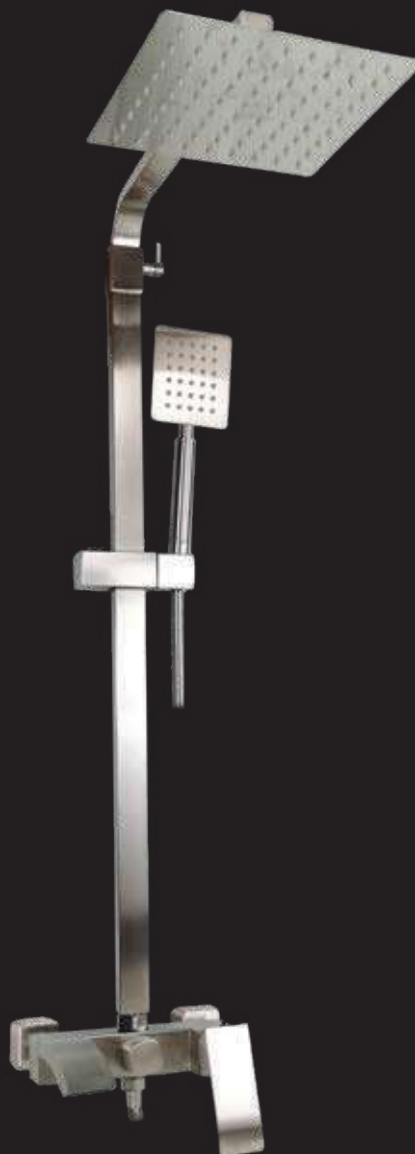

## COLUMNA DE DUCHA

Código	REF	Descripción
-	INOX-137	Incluye Monomando Ducha INOX-135

FABRICADAS CON ACERO INOXIDABLE 304

**2** años de Garantía



# REJILLAS



## REJILLA 10 CM X 10 CM

Código	REF	Descripción
-	INOX-601	-



## REJILLA 15 CM X 15 CM

Código	REF	Descripción
-	INOX-602	-

FABRICADAS CON ACERO INOXIDABLE 304

2 años de Garantía



CATÁLOGO



*Construye tu hogar...*

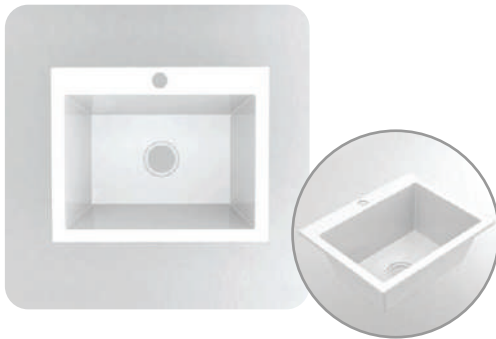

Código: UQ201010

**FRE-1001**

Fregadero sencillo 63 x 51 cm  
25" x 30"



Código: UQ201100

**FRE-1101**

Fregadero doble 84 x 56 cm  
33" x 22"

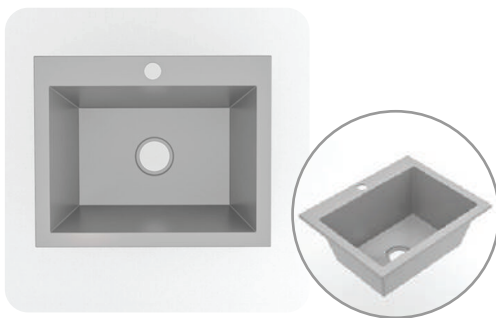

Código: UQ201011

**FRE-1002**

Fregadero sencillo 63 x 51 cm  
25" x 30"

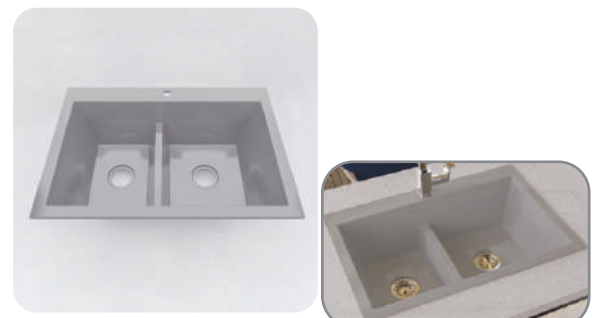

Código: UQ201101

**FRE-1102**

Fregadero doble 84 x 56 cm  
33" x 22"

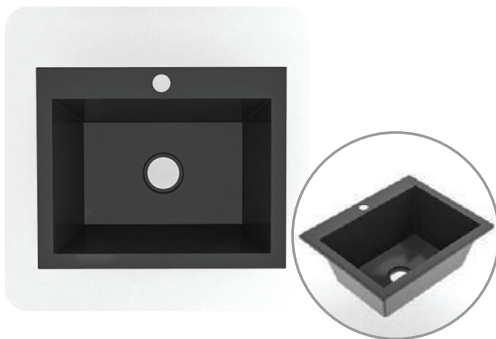

Código: UQ201012

**FRE-1003**

Fregadero sencillo 63 x 51 cm  
25" x 30"



Código: UQ201102

**FRE-1103**

Fregadero doble 84 x 56 cm  
33" x 22"



**PREMIUM**



Código	REF	Descripción
FM251003	<b>FRE-120</b>	22" x 17" x 8"

## Acero Inoxidable 304



Código	REF	Descripción
FM251009	<b>FRE-102</b>	22" x 17" x 8"

**PREMIUM**

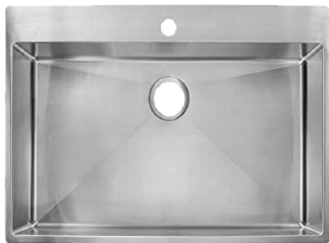

Código	REF	Descripción
FM250501	<b>FRE-603</b>	23.5" x 18" x 8"

Código	REF	Descripción
FM250513	<b>FRE-606</b>	28.5" x 16" x 8"

Código	REF	Descripción
FM250518	<b>FRE-608</b>	30" x 17" x 8"



## FREGADEROS SENCILLOS



Fregadero sencillo 21" x 20"

Código	REF	Descripción
FM 25 0003	FRE-18	21"x 20" Profundidad: 6"



Fregadero sencillo 25" x 22"

Código	REF	Descripción
FM 25 0004	FRE-19	25" x 22" Profundidad: 6"

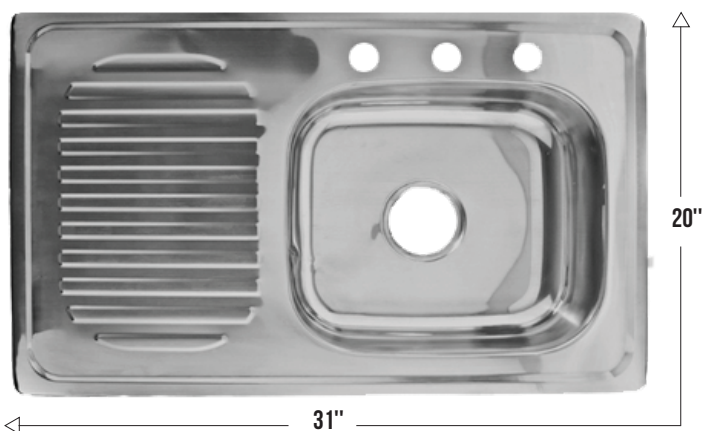

Fregadero C/ Escurridor Izquierdo

Código	REF	Descripción
FM 25 0021	FRE-02	31" x 20"

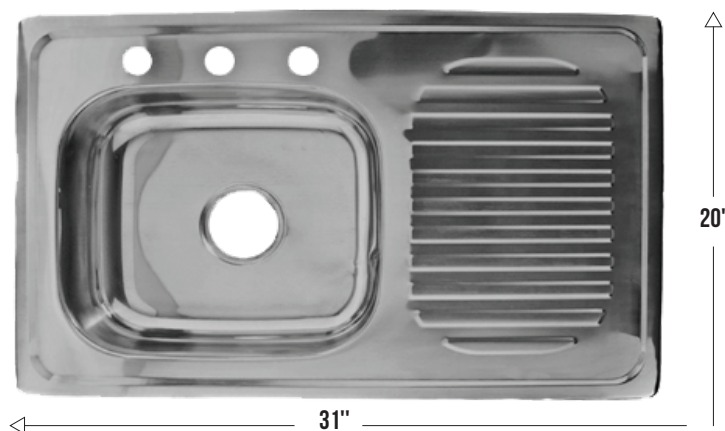

Fregadero C/ Escurridor Derecho

Código	REF	Descripción
FM 25 0022	FRE-03	31" x 20"



## FREGADEROS DOBLES

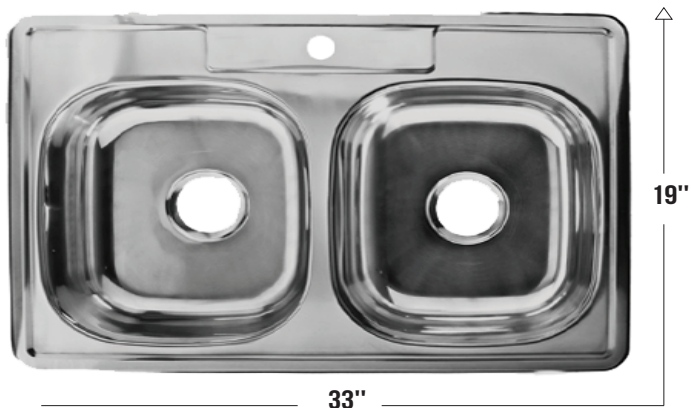

Fregadero doble 33" x 19" (1 Hueco)

Código	REF	Descripción
FM 25 0035	FRE-3319-1	33" x 19" Profundidad: 6"

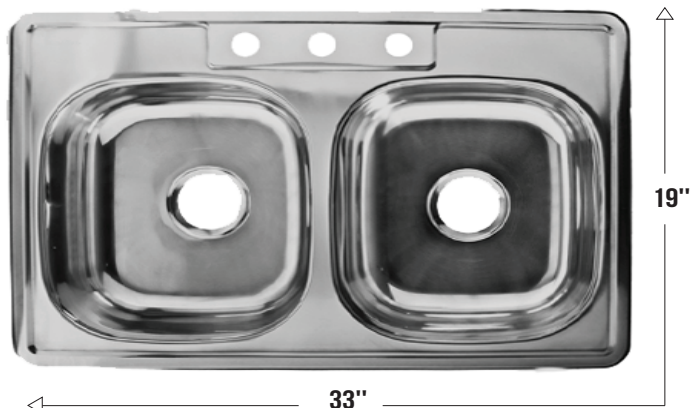

Fregadero doble 33" x 19" (3 Huecos)

Código	REF	Descripción
FM 25 0036	FRE-3319-3	33" x 19" Profundidad: 6"

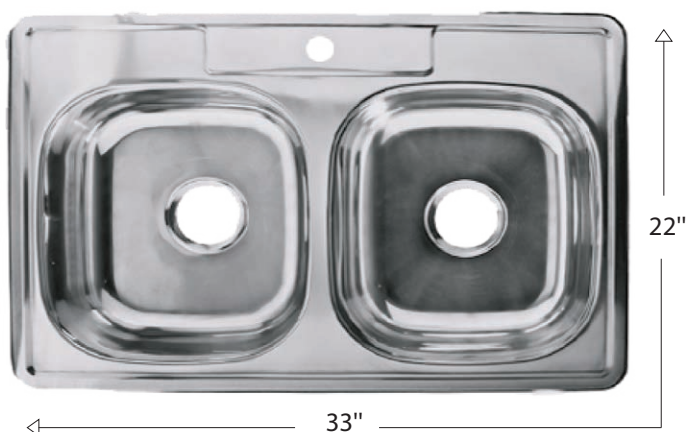

Fregadero doble 33" x 22" (1 Hueco)

Código	REF	Descripción
FM 25 0040	FRE-05-1	33" x 22" Profundidad: 6"

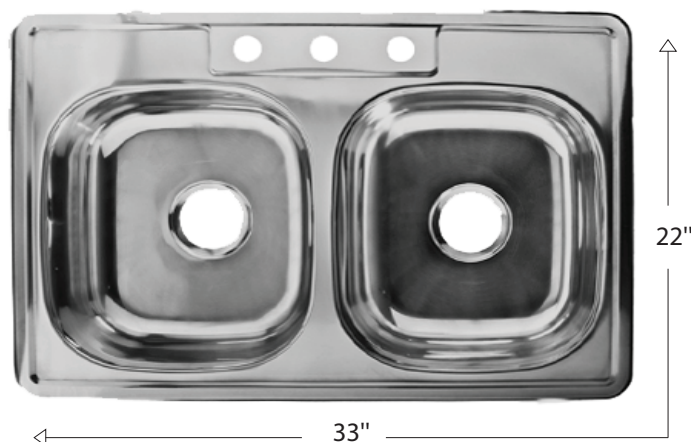

Fregadero doble 33" x 22" (3 Huecos)

Código	REF	Descripción
FM 25 0041	FRE-05	33" x 22" Profundidad: 6"



**Fregadero Esquinero doble**

Código	REF	Descripción
FM 25 0051	FRE-30	33" x 33" Profundidad: 6"



**Fregadero Triple 40" x 20" x 6"**

Código	REF	Descripción
FM 25 0048	FRE-10350	1 Hueco C/Colector completo

## FREGADEROS BAR



**Fregadero sencillo 15" x 15"**

Código	REF	Descripción
FM 25 0001	FRE-01	15" x 15"

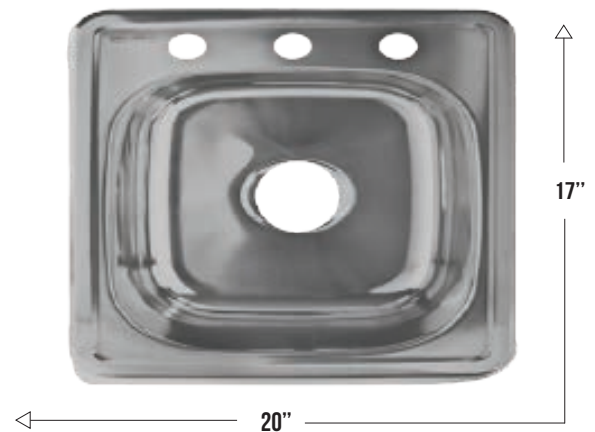

**Fregadero sencillo 20" x 17"**

Código	REF	Descripción
FM 25 0002	FRE-15	20" x 17"

## FREGADEROS REDONDOS



14"

Fregadero redondo sencillo

Código	REF	Descripción
FM 25 0101	FRE-31	Diametro 14"

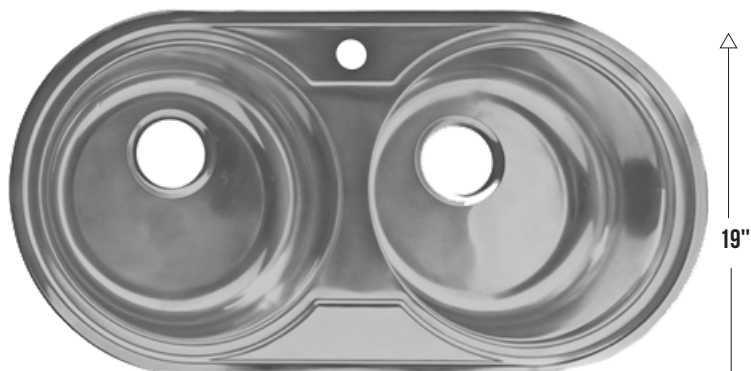

33"

Fregadero sencillo

Código	REF	Descripción
FM 25 0121	FRE-20	35" x 19" Profundidad: 6"



Fregadero C/ Escurridor Izquierdo

Código	REF	Descripción
FM 25 0111	FRE-21	C/ Escurridor ponchera derecha



Fregadero C/ Escurridor Derecho

Código	REF	Descripción
FM 25 0112	FRE-22	C/ Escurridor ponchera izquierda

PREMIUM



Tapa hueco para fregadero  
acero inoxidable con rosca

Código	REF	Descripción
FM 25 8003	TAP-1001	Acero Inoxidable



Tapa de hueco para  
fregadero y lavamanos

Código	REF	Descripción
FM 25 8001	TAP-02	Acero Inoxidable



Tapa de hueco para  
fregadero y lavamanos

Código	REF	Descripción
FM 25 8002	TAP-03	Acero Inoxidable



Cesta para fregadero

Código	REF	Descripción
FM 25 8011	CES-01	ABS cromado



Cesta para fregadero acero inoxidable

Código	REF	Descripción
FM 25 8014	CES-04	Acero Inoxidable

# PLOMERO EXPERTO



Código	Descripción
BS00 1001	No se agrieta, ni endurece, perfecta para lugares húmedos.

\*No usarse en mármol

¡EVITA QUE EL AGUA SE FILTRE EN TU FREGADERO  
CON LA MASILLA  
STAY SOFT

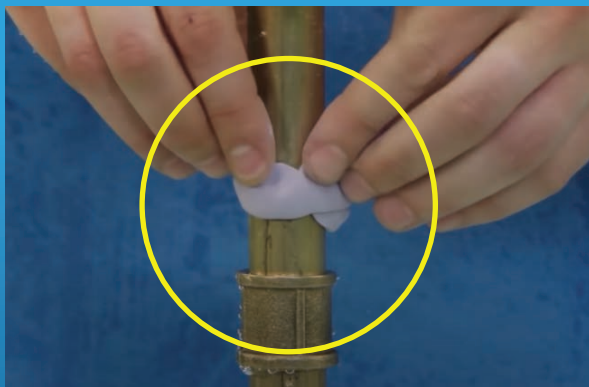

MASILLA EPÓXICA  
PARA REPARACIONES



Código	Descripción
BS00 1021	Se endurece en 20 minutos como el acero, para reparaciones en cualquier superficie

\*Puede usarse debajo del agua



TEFLÓN LIQUIDO

Código	Descripción
BS00 1031	Para usar en conexiones roscadas de metal y plástico. Se puede utilizar en todo tipo de sistemas que transporten casi cualquier gas o líquido excepto oxígeno, flúor y sodio líquido. No transfiere ningún sabor u olor al sistema que se está sellado. Excelente para sistemas de agua y alimentos. Rango de temperatura para gases y líquidos: -50° F (-45° C) hasta + 400° F (+ 204° C). Rango de presión para gases hasta 3,000 PSI, líquidos hasta 10,000 PSI.

# NUESTRO EXHIBIDOR DE FREGADEROS



**FRE-01**

**FRE-18**

**FRE-19**

**FRE-05 / FRE-05-1**  
**FRE-3319-1 / FRE-3319-3**

**EXH20002**

Exhibidor de pie de 4 fregaderos  
modelos: 01-18-19-05

[www.fermetal.com.do](http://www.fermetal.com.do)



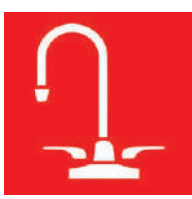

FERMETAL PREMIUM



Vástago Cerámico  
REP-224

Código	REF	Descripción
FM120013	GRI-224	Cromada Pomo <b>Cruz. 8"</b>



Vástago Cerámico  
REP-223



*Satinada*

Código	REF	Descripción
FM120500	GRI-220	Satinada, Cuello <b>90°. 8"</b>



Vástago Cerámico  
REP-223



Código	REF	Descripción
FM120010	GRI-221	Cromada Cuello <b>90°. 8"</b>



Vástago Cerámico  
REP-224



Código	REF	Descripción
FM120011	GRI-222	Cromada Cuello <b>Cisne. 8"</b>



Vástago Cerámico  
REP-224



Cuello  
Flexible

Código	REF	Descripción
FM120012	GRI-223	Cromada Cuello <b>Flexible. 8"</b>



Vástago Cerámico  
**REP-225**

Código	REF	Descripción
FM120510	<b>GRI-225</b>	1 vía, Cromada Pomo Palanca. 8"

*FERMETAL PREMIUM*



Código	REF	Descripción
FM101021	<b>V42</b>	Llave para Fregadero / Bar Altura: 32cm - 1/2"

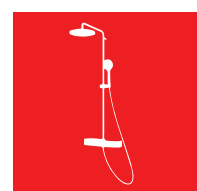

Cartucho Cerámico 35mm  
REP-218



Código	REF	Descripción
FM124103	GRI-511	Monomando para Lavamanos



Cartucho Cerámico 35mm  
REP-218



Código	REF	Descripción
FM125301	GRI-517	Columna de Ducha Para GRI-511



Cartucho Cerámico 35mm  
REP-218



Incluye Regadera y Mangueras



Código	REF	Descripción
FM125102	GRI-515	Monomando para Ducha

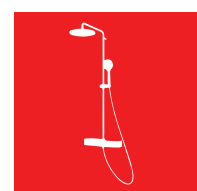

Cartucho Cerámico 35mm  
REP-218



Código	REF	Descripción
FM124104	GRI-521	Monomando Bajo
FM124105	GRI-522	Monomando Alto



Cartucho Cerámico 35mm  
REP-218



Código	REF	Descripción
FM125102	GRI-527	Columna de Ducha Para GRI-521



Cartucho Cerámico 35mm  
REP-218



Incluye Regadera y  
Mangueras

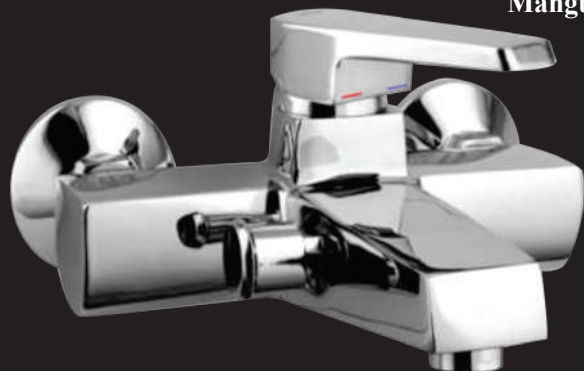

Código	REF	Descripción
FM125103	GRI-525	Monomando para ducha



Código	REF	Descripción
FM125121	GRI-531	Monomando para ducha de embutir

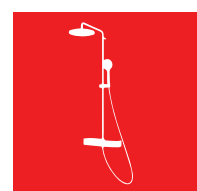

Cartucho Cerámico 35mm  
REP-218



Código	REF	Descripción
FM124106	GRI-523	Monomando Bajo
FM124107	GRI-524	Monomando Alto



Cartucho Cerámico 35mm  
REP-218

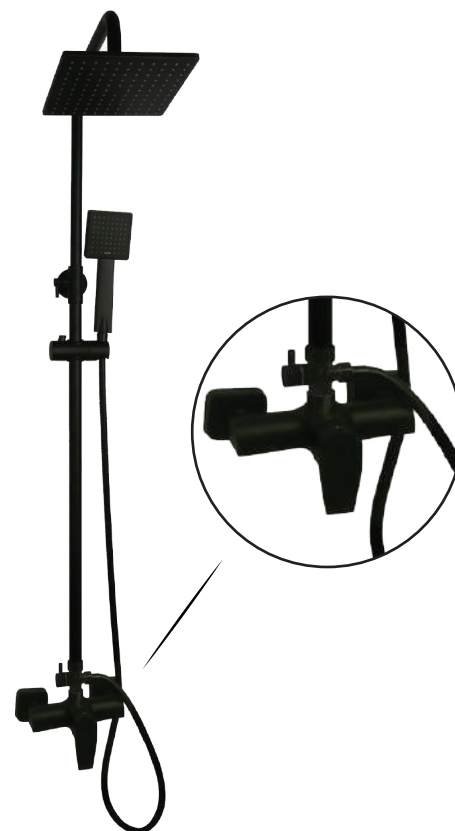

Código	REF	Descripción
FM1255303	GRI-530	Columna de Ducha Para GRI-523 / 254



Cartucho Cerámico 35mm  
REP-218



Incluye Regadera y  
Mangueras



Código	REF	Descripción
FM125104	GRI-526	Monomando para ducha



Código	REF	Descripción
FM125122	GRI-532	Monomando para ducha de embutir



Código	REF	Descripción
FM11003	GRI-74	Monomando para Lavamanos



Incluye Regadera y Mangueras

Código	REF	Descripción
FM112002	GRI-76	Monomando para Ducha



Cartucho Cerámico 35mm  
REP-219



Código	REF	Descripción
FM113000	GRI-974	Columna de Ducha Juego con GRI-74



Código	REF	Descripción
FM111004	GRI-75	Monomando para Lavamanos



Incluye Regadera y Mangueras

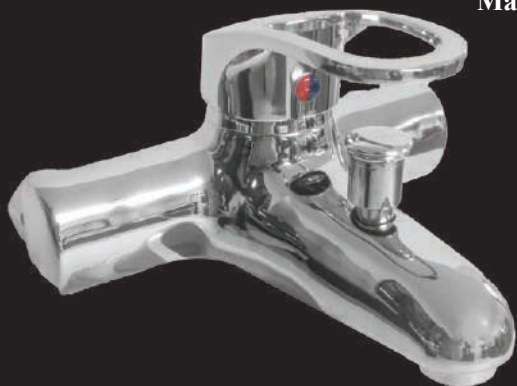

Código	REF	Descripción
FM112003	GRI-77	Monomando para Ducha



Cartucho Cerámico 35mm  
REP-219

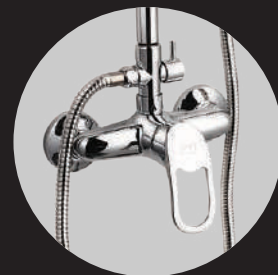

Código	REF	Descripción
FM113001	GRI-975	Columna de Ducha Juego con GRI-75

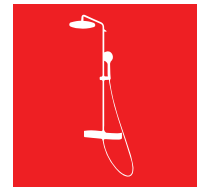

FERMETAL PREMIUM



Código	REF	Descripción
FM125321	GRI-528	Columna de Ducha Redonda



Código	REF	Descripción
FM125322	GRI-529	Columna de Ducha Cuadrada





Código	REF	Descripción
UQ104001	<b>GRI-8001</b>	Monomando para bañera con ducha de mano redonda



FERMETAL PREMIUM



Código	REF	Descripción
FM125503	<b>SHP-103</b>	Color: cromada brillante. Acero inoxidable



Código	REF	Descripción
FM125501	<b>SHP-101</b>	Color: gris. Acero inoxidable



FERMETAL PREMIUM



Código	REF	Descripción
FMSS0180	INOX-700	Color: satinado. Acero inoxidable



Código	REF	Descripción
FM125502	SHP-102	Color negra. Acero inoxidable

2 AÑOS DE GARANTÍA



## CROMADAS CUELLO CISNE

Código	REF	Descripción
FM 12 0001	<b>GRI-200</b>	Cierre de 1/4, Pomo <b>Cross. 8"</b>



Código	REF	Descripción
FM 12 0002	<b>GRI-201</b>	Cierre de 1/4, Pomo <b>Wing. 8"</b>



Código	REF	Descripción
FM 12 0003	<b>GRI-202</b>	Cierre de 1/4, Pomo <b>World. 8"</b>



Código	REF	Descripción
FM 12 0004	<b>GRI-203</b>	Cierre de 1/4, Pomo <b>Leg. 8"</b>



Código	REF	Descripción
FM 12 0005	<b>GRI-204</b>	Cierre de 1/4, Pomo <b>Crown. 8"</b>



## SATINADAS CUELLO CISNE

Código	REF	Descripción
FM 12 0101	<b>GRI-210</b>	Cierre de 1/4, Pomo <b>Cross. 8"</b>



Código	REF	Descripción
FM 12 0102	<b>GRI-211</b>	Cierre de 1/4, Pomo <b>Wing. 8"</b>



Código	REF	Descripción
FM 12 0103	<b>GRI-212</b>	Cierre de 1/4, Pomo <b>World. 8"</b>



Código	REF	Descripción
FM 12 0104	<b>GRI-213</b>	Cierre de 1/4, Pomo <b>Leg. 8"</b>



Código	REF	Descripción
FM 12 0105	<b>GRI-214</b>	Cierre de 1/4, Pomo <b>Crown. 8"</b>

## ABS CROMADO



Código	REF	Descripción
FM 10 0000	<b>GRI-17</b>	Cuello de 45°, cierre 1/4, Pomo <b>PP. 8"</b>

Código	REF	Descripción
FM 10 0003	<b>GRI-69</b>	Cuello cisne, cierre 1/4, Pomo <b>King II. 8"</b>



Código	REF	Descripción
FM 10 0001	<b>GRI-67</b>	Cuello de cisne, cierre 1/4, Pomo <b>Lev II. 8"</b>

Código	REF	Descripción
FM 10 0008	<b>GRI-1013C</b>	Cuello cisne, cierre 1/4, Pomo <b>Drop. 8"</b>



Código	REF	Descripción
FM 10 0007	<b>GRI-1013P</b>	Cuello de cisne, cierre 1/4, Pomo <b>Lev. 8"</b>

Código	REF	Descripción
FM 10 0009	<b>M-014</b>	Cuello de 90°, Pomo <b>Lev.</b>

**ENTRADA: NIPLÉ DE FIJACIÓN DE BRONCE**





Código	REF	Descripción
FM 10 1001	<b>GRI-12</b>	Cuello de 45°, cierre de 1/4, Pomo <b>PP. 10"</b>



Código	REF	Descripción
FM 10 1002	<b>GRI-32</b>	Cuello 90°, cierre de 1/4, Pomo <b>Lev. 10"</b>



Código	REF	Descripción
FM 10 1007	<b>GRI-52</b>	Cuello de 45°, cierre de 1/4, Pomo <b>King. 10"</b>



Código	REF	Descripción
FM 10 1011	<b>GRI-62</b>	Cuello de 90°, cierre de 1/4, Pomo <b>King. 10"</b>



Código	REF	Descripción
FM 10 1008	<b>GRI-58</b>	Cuello de 45°, cierre de 1/4, Pomo <b>Lev. 10"</b>



Código	REF	Descripción
FM 10 1009	<b>GRI-59</b>	Cuello de 90°, cierre de 1/4, Pomo <b>Drop. 10"</b>



Código	REF	Descripción
FM 10 1003	<b>GRI-39</b>	Vástago Cierre Compresión Pomo <b>Sayco. 10"</b>



Código	REF	Descripción
FM 10 1005	<b>GRI-42</b>	Cierre de 1/4 Pomo <b>Sayco. 10"</b>



Código	REF	Descripción
FM 10 1004	<b>GRI-41</b>	Cierre de 1/4 Pomo <b>Nibco. 10"</b>



Código	REF	Descripción
FM 10 1006	<b>GRI-43</b>	Cierre de 1/4 Pomo <b>Nibco. 10"</b>



## CUELLO FLEXIBLE



Código	REF	Descripción
FM 10 1051	<b>GRI-3000</b>	Cierre de 1/4. Ducha 2 posiciones, Pomo <b>King</b>



Código	REF	Descripción
FM 10 1052	<b>GRI-3001</b>	Cierre de 1/4. Ducha sencilla, Pomo <b>King</b>



Código	REF	Descripción
FM 10 1061	<b>GRI-3002</b>	Cierre de 1/4. Ducha 2 posiciones, Pomo <b>Lev</b>



Código	REF	Descripción
FM 10 1062	<b>GRI-3003</b>	Cierre de 1/4. Ducha sencilla, Pomo <b>Lev</b>



Código	REF	Descripción
FM 10 1071	<b>CU-01</b>	Repuesto, cuello flexible 2 posiciones



Código	REF	Descripción
FM 10 1072	<b>CU-02</b>	Repuesto, cuello flexible sencillo.



## CUELLO CISNE



Código	REF	Descripción
FM 12 0501	<b>GRI-250</b>	Doble. Cierre de 1/4 Pomo <b>Cross</b>



Código	REF	Descripción
FM 12 0502	<b>GRI-251</b>	Sencilla. Cierre de 1/4 Pomo <b>Cross</b>



Código	REF	Descripción
FM 12 0504	<b>GRI-253</b>	Doble. Cierre de 1/4 Pomo <b>Crown</b>



Código	REF	Descripción
FM 12 0503	<b>GRI-252</b>	Sencilla. Cierre 1/4 Pomo <b>Crown</b>

## CUELLO CISNE



Código	REF	Descripción
FM 10 1013	<b>GRI-28</b>	Doble. Cierre de 1/4 Pomo <b>King II</b>



Código	REF	Descripción
FM 10 1012	<b>GRI-27</b>	Sencilla. Cierre de 1/4 Pomo <b>King II</b>



Código	REF	Descripción
FM 10 1015	<b>GRI-38</b>	Doble. Cierre de 1/4 Pomo <b>Cruz</b>



Código	REF	Descripción
FM 10 1014	<b>GRI-37</b>	Sencilla. Cierre 1/4 Pomo <b>Cruz</b>

## LLAVES SENCILLAS



Código	REF	Descripción
FM 10 1018	<b>LLA-C113</b>	Sencilla <b>Palanca Lateral</b>

Código	REF	Descripción
FM 10 1017	<b>LLA-C109</b>	Sencilla. Cierre de 1/4 Pomo <b>Cruz</b>



Código	REF	Descripción
FM 10 1016	<b>LLA-C111</b>	Sencilla. Cuello cisne, Cierre de 1/4, Pomo <b>Lev</b>



Monomando para fregadero

## **GRI-680**

Con Mangueras 10mm x 3/8"

*Calidad en tu hogar...*



Código	REF	Descripción
FM 12 3021	<b>GRI-704</b>	Cromada, Cuello cisne de 8"



Brazo de  
Acero Inoxidable

Código	REF	Descripción
FM 12 0701	<b>GRI-680</b>	Cromada, Cuello 90° de 10"



Código	REF	Descripción
FM 12 3022	<b>GRI-705</b>	Satinada, Cuello cisne de 8"



Brazo de  
Acero Inoxidable

Código	REF	Descripción
FM 12 0702	<b>GRI-681</b>	Cromada, Cuello cisne de 10"



Incluye mangueras  
3/8" x 10mm



Código	REF	Descripción
FM 11 0101	<b>GRI-36</b>	Pico rociador extensible de 10"

Código	REF	Descripción
FM 11 0001	<b>GRI-02</b>	Con tubos de 1/2". 10"



Incluye mangueras  
3/8" x 10mm



**TU DECIDES COMO USARLA, CON BASE O SIN BASE**

Código	REF	Descripción
FM 11 0002	<b>GRI-25</b>	Largo de 10"



Código	REF	Descripción
FM 11 0011	<b>GRI-700</b>	Cuello cisne, Pomo <b>Prime. 8"</b>



Código	REF	Descripción
FM 11 0012	<b>GRI-701</b>	Cuello cisne, Pomo <b>Elite. 8"</b>



Código	REF	Descripción
FM 11 0013	<b>GRI-702</b>	Cuello flexible negro. 8"



Código	REF	Descripción
FM 11 0121	<b>GRI-706</b>	Cuello flexible, ducha 2 posiciones. 8"



Código	REF	Descripción
FM 12 1001	<b>GRI-100</b>	Cierre 1/4 Pomo <b>Cross</b>

Código	REF	Descripción
FM 12 1002	<b>GRI-101</b>	Cierre 1/4. Pomo <b>Wing</b>



Código	REF	Descripción
FM 12 1004	<b>GRI-102</b>	Cierre 1/4 Pomo <b>Leg</b>

Código	REF	Descripción
FM 12 1005	<b>GRI-104</b>	Cierre 1/4 Pomo <b>Crown</b>



2 AÑOS DE GARANTÍA

## CUELLO CISNE



Código	REF	Descripción
FM 12 1101	<b>GRI-150</b>	Cierre 1/4, Pomo <b>Cross. 4"</b>



Código	REF	Descripción
FM 12 1102	<b>GRI-151</b>	Cierre de 1/4, Pomo <b>Wing. 4"</b>



Código	REF	Descripción
FM 12 1103	<b>GRI-152</b>	Cierre 1/4, Pomo <b>Leg. 4"</b>



Código	REF	Descripción
FM 12 1105	<b>GRI-154</b>	Cierre 1/4, Pomo <b>Crown. 4"</b>



Código	REF	Descripción
FM 10 2001	<b>GRI-21</b>	Cierre de 1/4, Pomo <b>PP. 4"</b>

Código	REF	Descripción
FM 10 2002	<b>GRI-26</b>	Cierre de 1/4, Pomo <b>Lev II. 4"</b>



Código	REF	Descripción
FM 10 3001	<b>GRI-15</b>	Cierre de 1/4, Pomo <b>PP. 4"</b>

Código	REF	Descripción
FM 10 3002	<b>GRI-07</b>	Cierre de 1/4. Bronce Cromado, Pomo <b>Sayco. 4"</b>



Código	REF	Descripción
FM 10 3006	<b>GRI-56</b>	Cierre de 1/4. Bronce Cromado, Pomo <b>LEV. 4"</b>

Código	REF	Descripción
FM 10 3023	<b>GRI-55</b>	Cuello de cisne. Bronce Cromado, Pomo <b>Lev</b>

18 cm



18 cm



Código	REF	Descripción
FM 12 4001	<b>GRI-530</b>	Bajo Cuadrado

Código	REF	Descripción
FM 12 4002	<b>GRI-531</b>	Bajo Redondo

32 cm



32 cm



Código	REF	Descripción
FM 12 4051	<b>GRI-580</b>	Alto Cuadrado

Código	REF	Descripción
FM 12 4052	<b>GRI-581</b>	Alto Redondo

CONTROL DE AGUA



Monomando para lavamanos  
Con **Sensor**

Código	REF	Descripción
<b>FM 11 1801</b>	<b>GRI-C30</b>	Incluye sistema de instalación



Llave para lavamanos  
Push Button

**LLA-38**

Para uso institucional

*Calidad en tu hogar...*



Incluye regadera y mangueras



Código	REF	Descripción
FM 12 4102	<b>GRI-72</b>	Para lavamanos Cromado Brillante

Código	REF	Descripción
FM 12 5101	<b>GRI-79</b>	Para Ducha Cromada Brillante



Incluye regadera y mangueras



Código	REF	Descripción
FM 12 4151	<b>GRI-82</b>	Para lavamanos Satinado

Código	REF	Descripción
FM 12 5151	<b>GRI-83</b>	Para Ducha Satinado, con regadera y soporte



Código	REF	Descripción
FM 11 1001	<b>GRI-66</b>	Para lavamanos sin base

Código	REF	Descripción
FM 12 5001	<b>GRI-401</b>	Para Ducha de empotrar 40mm



Incluye regadera y manguera

Código	REF	Descripción
FM 11 1201	<b>GRI-53</b>	Para lavamanos 3 Huecos.

Código	REF	Descripción
FM 11 2000	<b>GRI-81</b>	Para Ducha Sin pico

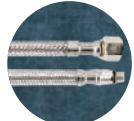

Incluye mangueras  
3/8" x 10mm



Incluye regadera  
y manguera



Código	REF	Descripción
FM 11 1000	<b>GRI-80</b>	Para lavamanos sin base

Código	REF	Descripción
FM 11 2001	<b>GRI-40</b>	Para Ducha Incluye soportes



Incluye mangueras  
3/8" x 10mm



Incluye regadera  
y manguera



Código	REF	Descripción
FM 11 1002	<b>GRI-73</b>	Para lavamanos Sin base

Código	REF	Descripción
FM 11 2004	<b>GRI-78</b>	Para Ducha Incluye soportes



Incluye mangueras  
3/8" x 10mm



Incluye regadera  
y manguera

Código	REF	Descripción
FM 11 1003	<b>GRI-74</b>	Para lavamanos sin base

Código	REF	Descripción
FM 11 2002	<b>GRI-76</b>	Para Ducha Incluye soportes



Incluye mangueras  
3/8" x 10mm

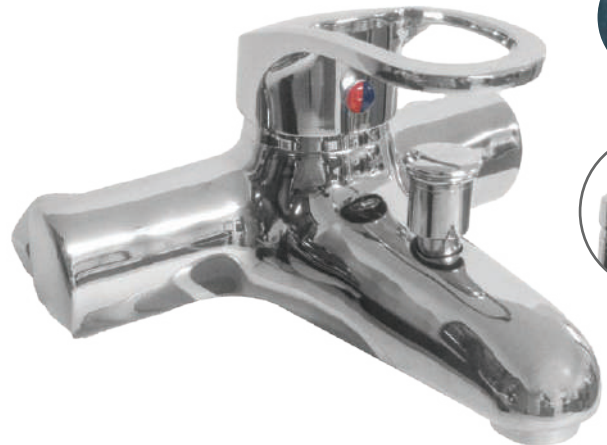

Incluye regadera  
y manguera

Código	REF	Descripción
FM 11 1004	<b>GRI-75</b>	Para lavamanos Sin base

Código	REF	Descripción
FM 11 2003	<b>GRI-77</b>	Para Ducha Incluye soportes





Código:

FM162010

Grifería lavamanos 1 vía cromada  
puño Cruz, cierre 1/4

REF:

**GRI-226**



Código:

FM162011

Grifería lavamanos 1 vía cromada  
puño palanca, cierre 1/4

REF:

**GRI-227**



Código:

FM162012

Grifería lavamanos 1 vía cromada baja  
cierre 1/4

REF:

**GRI-228**



Código:

FM162013

Grifería lavamanos 1 vía cromada alta  
cierre 1/4

REF:

**GRI-229**



Código	REF	Descripción
FM 16 1001	<b>LLA-100</b>	Para Lavamanos Pomo <b>Cross</b>



Código	REF	Descripción
FM 16 1002	<b>LLA-101</b>	Para lavamanos Pomo <b>Crown</b>



Código	REF	Descripción
FM 16 2001	<b>LLA-111</b>	Para Ducha Pomo <b>Cross</b>



Código	REF	Descripción
FM 16 2002	<b>LLA-112</b>	Para Ducha Pomo <b>Crown</b>



Código	REF	Descripción
FM 16 1003	<b>LLA-160</b>	Para Lavamanos Palanca <b>Larga</b>

FM-70

ABS CROMADO



Código	REF	Descripción
FM 15 1201	<b>LLA-80</b>	Pomo <b>Lev</b>



Código	REF	Descripción
FM 15 1203	<b>LLA-D100</b>	Pomo <b>DROP</b>



Código	REF	Descripción
FM 15 1251	<b>LLA-1005</b>	Cierre de 1/4 Manilla <b>Cruz</b>



Código	REF	Descripción
FM 15 1252	<b>LLA-C112</b>	Alta, mono control Cierre 1/4



Código	REF	Descripción
FM 15 1204	<b>LLA-D201</b>	Palanca larga



Código	REF	Descripción
FM 15 1003	<b>LLA-33</b>	Cierre de 1/4 Pomo <b>Drop</b>



Código	REF	Descripción
FM 15 1005	<b>LLA-35</b>	Cierre de 1/4 Pomo <b>Neru</b>



Código	REF	Descripción
FM 15 1007	<b>LLA-42</b>	Cierre de 1/4 Pomo <b>Sayco</b>



Código	REF	Descripción
FM 15 1002	<b>LLA-32</b>	Cierre de 1/4 Pomo <b>Twin</b>



Código	REF	Descripción
FM 15 1031	<b>LLA-38</b>	Push <b>Button</b>



Código	REF	Descripción
FM 15 1013	<b>LLA-104MF</b>	<b>Metálica</b>



## ABS CROMADO

Código	REF	Descripción
FM 15 1202	<b>LLA-C104LM</b>	<b>ABS</b>



Código	REF	Descripción
FM 15 1201	<b>LLA-03</b>	Cierre de 1/4 Pomo <b>Acrílico</b>



Código	REF	Descripción
FM 15 1012	<b>LLA-39</b>	Cierre de 1/4 Pomo <b>Acrílico</b>



Código	REF	Descripción
FM 15 2004	<b>LLA-70</b>	4 estrías 1/2"



Código	REF	Descripción
FM 15 2001	<b>LLA-02</b>	Para Ducha, cierre de 1/4 Pomo <b>PP</b>



Código	REF	Descripción
FM 15 2002	<b>LLA-40</b>	Cierre de 1/4 Pomo <b>Nibco</b>



Código	REF	Descripción
FM 15 2003	<b>LLA-41</b>	Cierre de 1/4 Pomo <b>Sayco</b>



Roscado

Código	REF	Descripción
DUR 15 001	<b>01512</b>	Llave para ducha Manilla Cruz 1/2"



Roscado

Código	REF	Descripción
DUR 15 002	<b>01521</b>	Llave para ducha Manilla PP 1/2"



Código	REF	Descripción
FM 19 4001	<b>CV222</b>	Cubrefalta para lavamanos <b>OVALADO</b>



Código	REF	Descripción
FM 19 3101	-	Tuercas para fijación de griferías



Incluye: Tornillos y tuercas



Código	REF	Descripción
FM 19 4021	<b>CV209</b>	Cubrefalta para fregadero <b>RECTO</b>



Código	REF	Descripción
FM 19 4022	<b>CV210</b>	Cubrefalta para fregadero <b>OVALADO</b>



CUBREFALTA HECHOS EN ITALIA

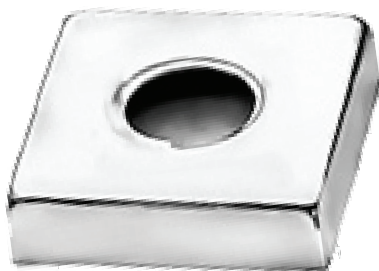

Código	Descripción
RIGHI 125	Cubrefalta <b>60 mm</b> diámetro <b>3/4"</b>

Código	Descripción
RIGHI 126	Cubrefalta <b>60 mm</b> diámetro <b>3/4"</b>

Código	Descripción
FM 19 3001 <b>NUT-01</b>	Kit de instalación para monomandos ducha.



Código	Descripción
RIGHI 101	Cubrefalta <b>55 mm</b> diámetro <b>1/2"</b>

Código	Descripción
RIGHI 102	Cubrefalta <b>60 mm</b> diámetro <b>1/2"</b>

Código	Descripción
RIGHI 124	Cubrefalta <b>70 mm</b> diámetro <b>3/4"</b>



Código	Descripción
RIGHI 121	Cubrefalta <b>60 mm</b> diámetro <b>3/4"</b>

Código	Descripción
RIGHI 122	Cubrefalta <b>65 mm</b> diámetro <b>3/4"</b>

Código	Descripción
RIGHI 123	Cubrefalta <b>70 mm</b> diámetro <b>3/4"</b>







FERMETAL PREMIUM



**Regadera porta Ducha  
de mano y Diversor**

Código	REF	Descripción
FM322301	REG-201	Kit



**Regadera con Ducha  
de mano y diversor**

Código	REF	Descripción
FM322300	REG-202	Kit



Código	REF	Descripción
FM323001	REG-203	Regadera Deslizable en Barra



FERMETAL PREMIUM



1.50 mts



5 Posiciones

Código	REF	Descripción
FM323050	REG-204	Incluye Manguera y Soporte



1.50 mts

Código	REF	Descripción
FM323052	REG-206	Incluye manguera y soporte



1.50 mts

Código	REF	Descripción
FM323051	REG-205	Incluye Manguera y Soporte



Código	REF	Descripción
FM323901	REG-207	Soporte Ducha Redondo



Código	REF	Descripción
FM323902	REG-208	Soporte Ducha Cuadrado



Código	REF	Descripción
FM323903	REG-209	Soporte Para Ducha



Código	REF	Descripción
UQ101901	REP-220	Regadera para GRI-600



ABS Cromado

Código	REF	Descripción
FM 32 0001	ACC-01	5 Piezas



Cromado metálico

Código	REF	Descripción
FM 32 0002	ACC-02	6 Piezas



Cromado metálico

Código	REF	Descripción
FM 32 0003	ACC-04	Cromo - Cristal, 6 Piezas



Cromado metálico

Código	REF	Descripción
FM 32 0004	ACC-07	6 Piezas



Cromado metálico

Código	REF	Descripción
FM 32 0005	ACC-08	6 Piezas



Cromado metálico

Código	REF	Descripción
FM 32 0006	ACC-09	6 Piezas



Código	REF	Descripción
FM 32 0111	<b>ACC-D305</b>	Jabonera individual Cromada. Blister.



Código	REF	Descripción
FM 32 0112	<b>ACC-D306</b>	Toallero individual Cromado. Blister.



Código	REF	Descripción
FM 32 0113	<b>ACC-D307</b>	Porta papel individual Cromado. Blister



Los mejores accesorios de baño

Construye tu hogar...

## REGADERAS



Código	REF	Descripción
FM 32 2001	<b>REG-03</b>	Presión ABS Cromado.



Código	REF	Descripción
FM 32 2002	<b>REG-06</b>	Clásica ABS Cromado.



Código	REF	Descripción
FM 32 2005	<b>R-003</b>	2 posiciones, ABS cromado.



Código	REF	Descripción
FM 32 2006	<b>R-006</b>	5 posiciones, ABS cromado.



Código	REF	Descripción
FM 32 2003	<b>REG-11</b>	Masajeadora, 5 posiciones <b>Modelo B</b>



Código	REF	Descripción
FM 32 2004	<b>REG-12</b>	Masajeadora, 3 posiciones <b>Modelo C</b>

## REGADERAS COMPLETAS



Código	REF	Descripción
FM 32 2101	<b>R-004</b>	Redonda. <b>6"</b> Incluye: brazo y cubrefalta.



Código	REF	Descripción
FM 32 2103	<b>R-007</b>	Cuadrada. <b>6"</b> Incluye: brazo y cubrefalta.



Código	REF	Descripción
FM 32 2102	<b>R-001</b>	Redonda. <b>8"</b> Incluye: brazo y cubrefalta.



Código	REF	Descripción
FM 32 2104	<b>R-002</b>	Cuadrada. <b>8"</b> Incluye: brazo y cubrefalta.

## REGADERAS



Código	REF	Descripción
FM 32 2208	<b>REG-27</b>	Anticalcárica. 6" Modelo Sky I

Código	REF	Descripción
FM 32 2209	<b>REG-28</b>	Anticalcárica. 6" Modelo Sky II



Código	REF	Descripción
FM 32 2005	<b>REG-25</b>	Anticalcárica. 7" Modelo Square III

Código	REF	Descripción
FM 32 2003	<b>REG-26</b>	Anticalcárica. 8" Modelo World III

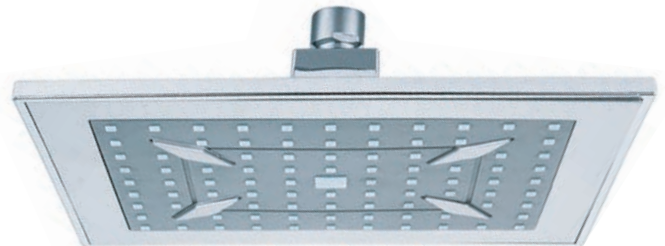
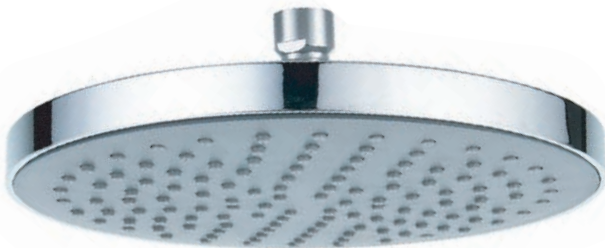

Código	REF	Descripción
FM 32 2201	<b>REG-20</b>	Anticalcárica. 9" Modelo World

Código	REF	Descripción
FM 32 2206	<b>REG-23</b>	Anticalcárica. 9" Modelo Rectangle



## BRAZOS PARA REGADERA



Código	REF	Descripción
FM 32 2011	<b>BRA-01</b>	Brazo para regadera 6" Metálico



Código	REF	Descripción
FM 32 2012	<b>BRA-15</b>	Brazo para regadera con roseta. Blister. 10"



Código	REF	Descripción
FM 32 2802	<b>BRA-11</b>	Brazo de 90°, 45cm (1.5 ft)



Código	REF	Descripción
FM 32 2803	<b>BRA-12</b>	Brazo tipo Sifón 45cm (1.5 ft)



Código	REF	Descripción
FM 32 2020	<b>RD-DER-01</b>	Derivador para brazo de regadera y ducha de mano.



Código	REF	Descripción
FM 55 0021	<b>ROS-05</b>	Cubrefalta 1/4"
FM 55 0021	<b>ROS-04</b>	Cubrefalta 3/8"
FM 55 0021	<b>ROS-01</b>	Cubrefalta 1/2"

## DUCHAS



Código	REF	Descripción
FM 32 1002	<b>DUC-02</b>	Ducha tipo telefono. ABS Cromado



Código	REF	Descripción
FM 32 1003	<b>DUC-03</b>	Ducha tipo telefono cromada



Código	REF	Descripción
FM321701	<b>DUC-C07</b>	Regadera para ducha con manguera de 5FT



Código	REF	Descripción
FM 32 1004	<b>DUC-D04</b>	Ducha tipo telefono Blanca/Cromada



Código	REF	Descripción
FM 32 3011	<b>DUC-102</b>	Ducha tipo telefono, Con Manguera y soportes

## MANGUERAS



Código	REF	Descripción
FM 32 1801	<b>TUB-RD20</b>	Manguera Flexible 1/2" x 1/2" <b>4 ft. (1.20mts)</b>

FM 32 1802	<b>TUB-RD21</b>	Manguera Flexible 1/2" x 1/2" <b>5 ft. (1.250mts)</b>
------------	-----------------	---



Código	REF	Descripción
FM 32 1811	<b>TUB-RD22</b>	Manguera Flexible 1/2" x 1/2" <b>4 ft. (1.20mts)</b>

FM 32 1812	<b>TUB-RD23</b>	Manguera Flexible 1/2" x 1/2" <b>5 ft. (1.250mts)</b>
------------	-----------------	---

PREMIUM



Rejilla Estrella Cuadrada

Código	REF	Descripción
FM 20 3101	REJ-110	2"

PREMIUM



Rejilla Estandar Cuadrada

Código	REF	Descripción
FM 20 3102	REJ-111	2"

PREMIUM



Rejilla estandar de Lujo metal pesada

Código	REF	Descripción
FM 20 3202	REJ-11	2"

PREMIUM



Rejilla Ciega Pesada

Código	REF	Descripción
FM 20 3203	REJ-12	2"

## Rejillas de 7cm x 7cm

PREMIUM



PARA TUBOS DE 1 1/2" Y 2"



Rejilla Anticucarachas Cuadrada

Código	REF	Descripción
FM 20 3103	REJ-112	2"



Blister



## Rejillas de 9cm x 9cm

PREMIUM



Rejilla Estandar Cuadrada de Lujo

Código	REF	Descripción
FM 20 3201	REJ-10	2"

## Plásticas



Rejilla estandar  
Sin rosca

Código	REF	Descripción
FM 20 3001	REJ-13	1 1/2"
FM 20 3002	REJ-14	2"

## Metal Livianas



Rejilla estandar

Código	REF	Descripción
FM 20 3011	REJ-01	1 1/2"
FM 20 3012	REJ-02	2"

## Bronce Cromado



Rejilla anticucarachas  
metal pesada

Código	REF	Descripción
FM 20 3031	REJ-05	1 1/2"
FM 20 3032	REJ-06	2"



Rejilla estandar  
metal pesada

Código	REF	Descripción
FM 20 3021	REJ-03	1 1/2"
FM 20 3022	REJ-04	2"



Rejilla ciega pesada

Código	REF	Descripción
FM 20 3041	REJ-07	1 1/2"
FM 20 3042	REJ-08	2"

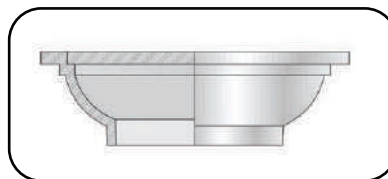

Rejilla

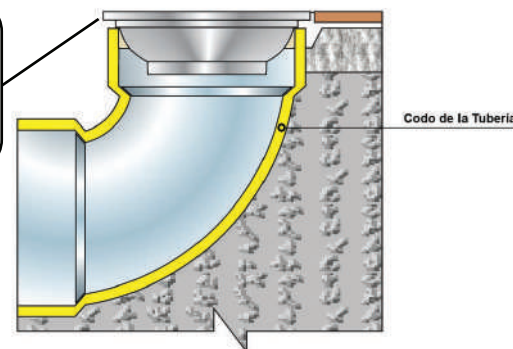

Codo de la Tubería



**Llave arresto angular 3/8" x 3/8"**

Código	REF	Descripción
FM 15 0001	LLA-62	Llave angular



**Llave de arresto angular 1/2" x 3/8"**

Código	REF	Descripción
FM 15 0003	LLA-63	• CAJA
FM 15 0005	LLA-66	• BLISTER



Presentación:  
 • LLA-63  
 • LLA-66



**Llave arresto angular  
1/2" x 3/8" x 3/8"**

Código	REF	Descripción
FM 15 0006	LLA-64	Llave angular doble



**Llave de arresto angular  
1/2" x 1/2"**

Código	REF	Descripción
FM 15 0007	LLA-01	Llave angular



**Llave de arresto angular 1/2" x 3/8"**

Código	REF	Descripción
FM 15 0031	LLA-83	Llave Premium



**Llave de arresto angular  
1/2" x 3/8" x 3/8"**

Código	REF	Descripción
FM 15 0032	LLA-84	Llave Premium



**Llave angular**  
**1/2" x 3/8"**

Código	REF	Descripción
FM 15 0009	LLA-65	1/4 de cierre



**Llave angular Trion**  
**1/2" x 1/2"**

Código	REF	Descripción
FM 15 0021	LLA-34	Hembra x Macho



**Llave de Lujo**  
**1/2" x 3/8"**

Código	REF	Descripción
FM 15 0015	LLA-107	Hembra x Macho



**Llave de Lujo**  
**1/2" x 1/2"**

Código	REF	Descripción
FM 15 0016	LLA-106	Hembra x Macho

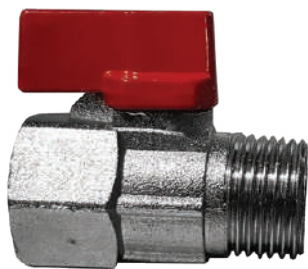

**Mini valvula de bola**  
**Cromada 1/2" x 1/2"**

Código	REF	Descripción
FM 15 0011	LLA-06	Hembra x Macho



**Mini Valvula de bola**  
**Cromada lisa 1/2" x 1/2"**

Código	REF	Descripción
FM 15 0051	LLA-74	Hembra x Macho



Llave angular  
1/2" x 3/8"

Código	Descripción
FM 15 0041	Hembra x Macho



Llave angular Doble  
1/2" x 3/8" x 3/8"

Código	Descripción
FM 15 0042	Hembra x Macho x Macho



Llave angular  
1/2" x 1/2"

Código	Descripción
FM 15 0043	Hembra x Macho



Llave angular  
1/2" x 1/2" x 1/2"

Código	Descripción
FM 15 0044	Hembra x Macho x Macho



Llave doble control  
1/2" x 3/8" x 3/8"

Código	Descripción
FM 15 0045	Macho x macho x macho

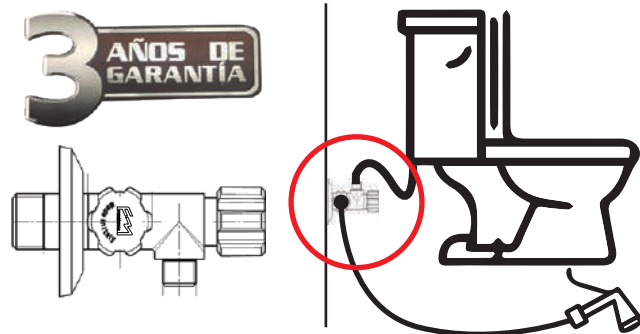

Conecta simultáneamente tu ducha lavapelo ó lavamanos junto a tu inodoro.

# NUEVOS PRODUCTOS



MPT80001  
LAVADERO PLÁSTICO

**50cm x 34 cm x H 21cm**  
**(20" x 13.3" x 8.2")**

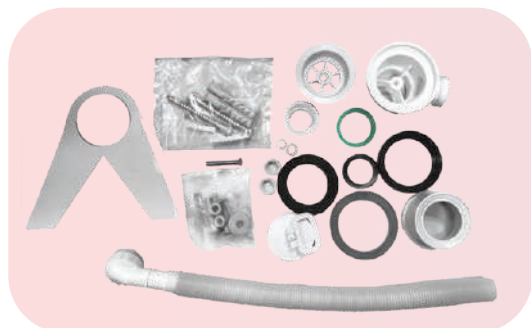

Incluyen todo lo necesario para su  
instalación:  
**Boquilla, Rebosadero, Tarugos y tornillos**



MPT80003  
LAVADERO PLÁSTICO

**55cm x 34 cm x H 21cm**  
**(22" x 13.3" x 8.2")**





## Manguera para mezcladora 1/2" x 3/8"

Manguera en Pvc **Hembra x Hembra** con tuercas de latón cromado

Código	REF	Descripción
FM 20 4561	TUB-35	1/2" x 3/8" Largo 16"
FM 20 4562	TUB-27	1/2" X 3/8" Largo 20"



## Manguera para mezcladora 1/2" x 1/2"

Manguera en Pvc **Hembra x Hembra** con tuerca de latón cromado

Código	REF	Descripción
FM 20 4571	TUB-24	1/2" x 1/2" Largo 16"
FM 20 4572	TUB-28	1/2" x 1/2" Largo 20"



## Manguera para inodoro 3/8" x 7/8"

Manguera en Pvc **Hembra x Hembra** con tuerca de latón cromado

Código	REF	Descripción
FM 20 4581	TUB-36	3/8"x7/8" Largo 16"
FM 20 4582	TUB-37	3/8"x7/8" Largo 20"
FM 20 4583	TUB-38	3/8"x7/8" Largo 24"



## Manguera para grifería H x M

Código	REF	Descripción
FM 20 4201	TUB-15RD	3/8" x 10mm" Largo 18"
FM 20 4292	TUB-21	3/8" x 10mm" Largo 20"
FM 20 4593	TUB-22	3/8" x 10mm" Largo 24"
FM 20 4594	TUB-39	3/8" x 10mm" Largo 30"



## Push Button



**Boquillas ABS**

Código	REF	Descripción
FM 20 0206	DES-118	Con rebosadero



CON REBOSADERO



CON Y SIN REBOSADERO



MADE IN ITALY

**Boquilla Push Button P/lavamanos 1-1/4"**

Código	REF	Descripción
FM 20 0620	DES-1001	Rebosadero Opcional



**Boquillas Lavamanos Pequeño Blanco**

Código	REF	Descripción
FM 20 0207	DES-119	Push Button



CON REBOSADERO



**Boquillas ABS**

Código	REF	Descripción
FM 20 0205	DES-14	Sin rebosadero



SIN REBOSADERO

## Bronce Cromado



**Boquillas Lavamanos Metálica Cromada**

Código	REF	Descripción
FM 20 0201	DES-09	Push Button



CON REBOSADERO



**Boquillas Push Button Metálica Sin Rebosadero**

Código	REF	Descripción
FM 20 0200	DES-120	Push Button



SIN REBOSADERO

## ABS

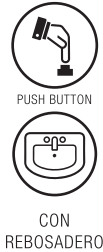

Boquillas Lavamanos ABS

Código	REF	Descripción
<b>FM 20 0202</b>	DES-03-1	Con cadena y tapón

## Bronce Cromado

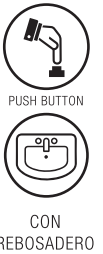

Boquillas para Lavamanos Metálica

Código	REF	Descripción
<b>FM 20 0203</b>	DES-06	Desagüe automático

## Flexibles



Boquillas Lavamanos 1/4"  
PVC.

Código	REF	Descripción
<b>FM 20 0511</b>	DES-70	1 1/4"



Boquillas Lavamanos 1/4"  
Cromado

Código	REF	Descripción
<b>FM 20 0512</b>	DES-71	1 1/4"

## Flexibles



**Boquilla para fregadero con sifón Extensible**

Código	REF	Descripción
<b>FM 20 0502</b>	DES-83	Para Fregadero



**Boquilla para fregadero con sifón Extensible**

Código	REF	Descripción
<b>FM 20 0503</b>	DES-84	Para Lavamanos



**Boquillas para lavadero con Sifón extensible**

Código	REF	Descripción
<b>FM 20 0501</b>	DES-80	1 1/4"

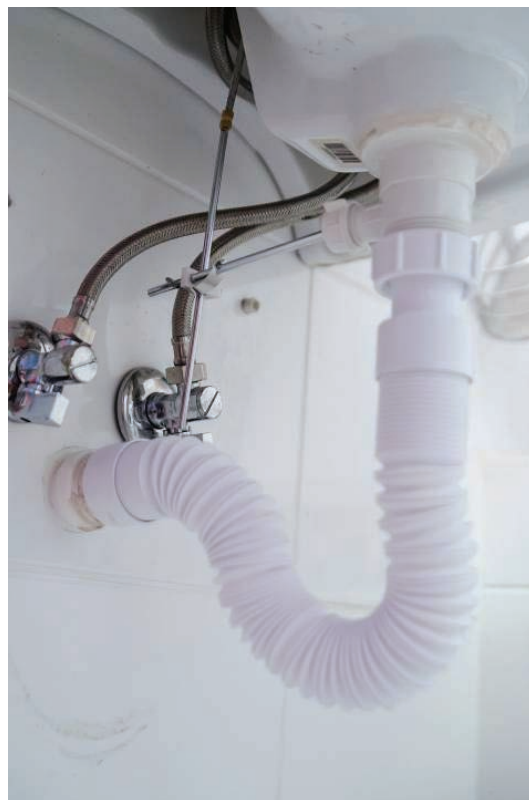

Boquillas Flexibles

## Metálicos



Boquillas Lavamanos Metálico  
Tipo POP-UP con Rebosadero

**DESAGUES  
101 - 102**

Código	REF	Descripción
FM 20 0204	DES-100	Push Button metálico

## Para Lavamanos de Sobreponer



Boquillas  
Redondo Push Button.

Boquillas  
Cuadrado Push Button.

Código	REF	Descripción
FM 20 0601	DES-101	Push Button redondo.

Código	REF	Descripción
FM 20 0602	DES-102	Push Button cuadrado



**Colector Doble  
Bronce Cromado 1 1/2"**

Código	REF	Descripción
<b>FM 20 1115</b>	COL-02	1 1/2"



**Colector Doble para  
Fregadero ABS Cromado**

Código	REF	Descripción
<b>FM 20 1111</b>	COL-01	1 1/2"

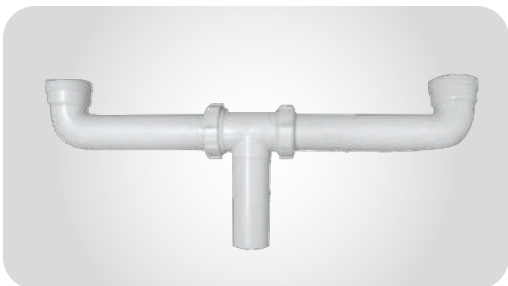

**Colector Doble 1 1/2"  
Plástico**

Código	REF	Descripción
<b>FM 20 1102</b>	COL-04	1 1/2"



**Colector Extensible 1 1/2"  
Tipo "Y" Plástico**

Código	REF	Descripción
<b>FM 20 1101</b>	COL-03	1 1/2"



**Sifón Extensible  
1 1/2" - 1 1/4"**

Código	REF	Descripción
<b>FM 20 1002</b>	SIF-08	1 1/2" - 1 1/4"

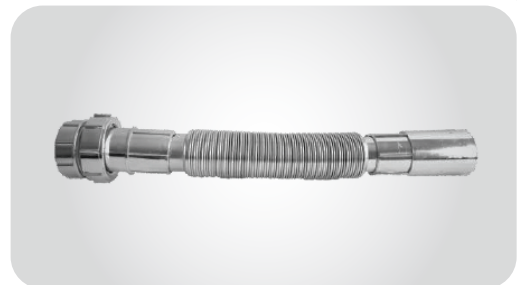

**Sifón Extensible Cromado  
1 1/2" - 1 1/4"**

Código	REF	Descripción
<b>FM 20 1003</b>	SIF-C08-1	1 1/2" - 1 1/4"

**PREMIUM**



MADE IN ITALY

**Fabricados en Italia**



Sifón doble para fregadero con rosca

	REF	Descripción
<b>FM 20 1210</b>	SIF-1010	Plástico



Sifón extensible doble con rosca 1-1/2"

	Código	REF	Descripción
<b>FM 20 1211</b>	SIF-1011		Plástico



Sifón con rosca 1-1/2" con adaptador 1-1/4"

	Código	REF	Descripción
<b>FM 20 1200</b>	SIF-1001		Plástico

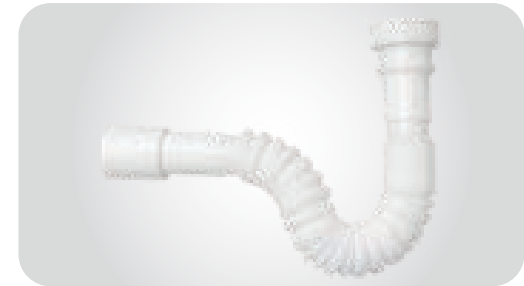

Sifón Extensible con rosca 1-1/2" a 1-1/4" con rosca

	Código	REF	Descripción
<b>FM 20 1201</b>	SIF-1002		1 1/2" - 1 1/4"

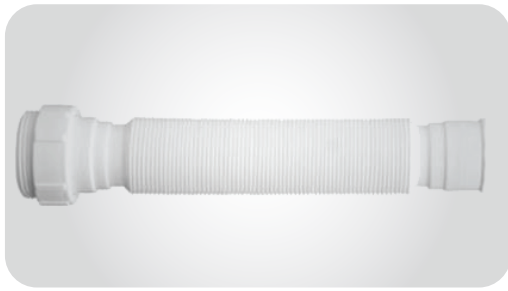

**Sifón extensible blanco**  
1-1/2" a 1-1/4" con rosca

Código	REF	Descripción
FM 20 1004	DES-82	1 1/2" - 1 1/4"



**Sifón Lavamanos/ Fregadero**  
1 1/2" con adaptador 1 1/4"

Código	REF	Descripción
FM 20 1001	SIF-07	Sifón de plástico

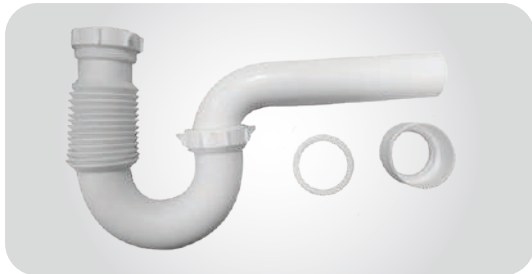

**Sifón**  
con Adaptador Extensible Plástico

Código	REF	Descripción
FM 20 1000	SIF-15	1 1/2" - 1 1/4"



**Sifón para Lavamanos**  
ABS Cromado

Código	REF	Descripción
FM 20 1011	SIF-01	Lavamanos
FM 20 1012	SIF-02	Fregadero



**Sifón Lavamanos**  
Bronce Cromado

Código	REF	Descripción
FM 20 1021	SIF-03	1/4"



**Facilita la instalación de tu sifón al drenaje:  
para lavamanos, lavaderos y fregaderos**



**Goma Reductora**

Código	REF	Descripción
FM 19 5001	HYD-PR-32	2" x 1/4" Lavamanos
FM 19 5002	HYD-PR40	2" x 1/2" Fregadero

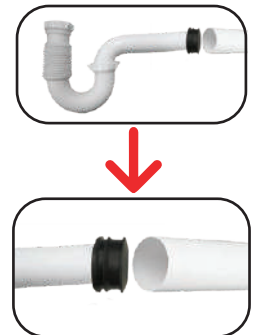





**Desagüe ABS Cromado  
sin Colaboquilla**

Código	REF	Descripción
<b>FM 20 0002</b>	DES-02-1	ABS Cromado



**Desagüe ABS blanco  
con Colaboquilla**

Código	REF	Descripción
<b>FM 20 0003</b>	DES-12	ABS



**Desagüe para Fregadero  
Acero sin colaquilla**

Código	REF	Descripción
<b>FM 20 0001</b>	DES-01-1	Metálico



**Boquilla para fregadero  
Push Button 1-1/2"**

Código	REF	Descripción
<b>FM 20 0640</b>	DES-1041	1-1/2" Plástica



**Boquilla para lavadero con tapón  
1-1/2"**

Código	REF	Descripción
<b>FM 20 0630</b>	DES-1021	Plástica



**Desagüe para Lavadero 2 1/2"  
Metal - Plástico**

Código	REF	Descripción
<b>FM 20 0102</b>	DES-13	Con Colaboquilla



Desagüe para Fregadero  
de 3 poncheras

Código	REF	Descripción
<b>FM 20 0006</b>		Plástico



Desagüe para Fregadero  
con extensión al rebosador

Código	REF	Descripción
<b>FM 20 0005</b>		Plástico

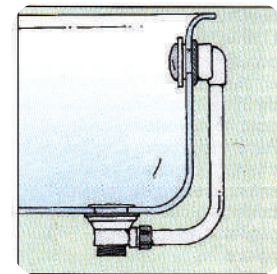

Desagüe para bañera

Código	REF	Descripción
<b>FM 20 0401</b>	DES-10	Desagüe para bañera



**Colaboquilla  
para Lavamanos**

Código	REF	Descripción
<b>FM 20 1381</b>	EXT-60	<b>1 1/4" x 6"</b>



**Colaboquilla  
para Fregadero**

Código	REF	Descripción
<b>FM 20 1385</b>	EXT-61	<b>1 1/2" x 4"</b>
<b>FM 20 1404</b>	EXT-36	<b>1 1/2" x 10"</b>



**Extension en PVC 1 1/4"**

Código	REF	Descripción
<b>FM 20 1391</b>	EXT-38	<b>1 1/4" x 6" en PVC</b>
<b>FM 20 1392</b>	EXT-39	<b>1 1/4" x 8" en PVC</b>



**Extensión en PVC 1 1/2"**

Código	REF	Descripción
<b>FM 20 1401</b>	EXT-33	<b>1 1/2" x 4" en PVC</b>
<b>FM 20 1402</b>	EXT-34	<b>1 1/2" x 6" en PVC</b>
<b>FM 20 1403</b>	EXT-35	<b>1 1/2" x 8" en PVC</b>



**Extesion Cromada 1 1/4"**

Código	REF	Descripción
<b>FM 20 1421</b>	EXT-45	<b>1 1/4" 6" Cromada</b>
<b>FM 20 1422</b>	EXT-46	<b>1 1/4" 8" Cromada</b>



**Extension Cromada 1 1/2"**

Código	REF	Descripción
<b>FM 20 1431</b>	EXT-48	<b>1 1/2" 6" Cromada</b>
<b>FM 20 1432</b>	EXT-49	<b>1 1/2" 8" Cromada</b>

## Flotantes para tinaco



Boya de repuesto

FM 15 5111 BOL-07 PARA FLO-07  
 FM 15 5112 BOL-08 PARA FLO-08  
 FM 15 5113 BOL-09 PARA FLO-09

Flotante fijo para Tinaco

Código	REF	Descripción
FM 15 5101	FLO-07	1/2"
FM 15 5102	FLO-08	3/4"
FM 15 5103	FLO-09	1"



PREMIUM

- ALTURA AJUSTABLE
- BARRA DE ACERO INOXIDABLE

Flotante para tinaco

Código	REF	Descripción
FM 16 5031	FLO-10	1/2"
FM 16 5032	FLO-11	3/4"
FM 16 5033	FLO-12	1"
ESSETI 04	ITALY	1¼"
ESSETI 05	ITALY	1½"
ESSETI 06	ITALY	2"



Flotante ajustable con Boya

Código	REF	Descripción
FM 15 5131	FLO-14	1/2"
FM 15 5132	FLO-15	3/4"

## Flotante eléctrico



Flotante Eléctrico con contrapeso

Código	REF	Descripción
FM 15 5121	FLO-05	3 mts
FM 15 5122	SW-01	Contrapeso

## Conexión para tinaco



Conexión para tinaco

Código	REF	Descripción
FMPVC 201	TAD-01	1/2"
FMPVC 202	TAD-02	3/4"
FMPVC 203	TAD-03	1"

## LLaves de Bola para Manguera



Llave 1/2" x 3/4" con Espiga 1/2"

Código	REF	Descripción
FM 15 3011	LLA-05	1/2"



Conexión de Bronce



PVC reforzado

Llave 1/2" x 3/4" con espiga 1/2"

Código	REF	Descripción
FM 15 3012	LLA-D08	PVC Reforzada

## LLaves de PVC para Manguera



Llave de PVC 1/2" x 3/4"

Código	REF	Descripción
FM 15 3101	LLA-78	PVC



Llave de PVC 3/4" x 3/4"

Código	REF	Descripción
FM 15 3102	LLA-82	PVC

## LLaves para Lavaderos



Llave Tipo Florón 1/2" con Palanca

Código	REF	Descripción
FM 15 3110	LLA-D106	ABS Cromado



Llave Manilla Tipo Cruz

Código	REF	Descripción
FM 15 3120	LLA-D2003	Abs Cromado

## LLAVES de Bola para Manguera



Llave Manilla Mariposa 1/2" x 3/4"

Código	REF	Descripción
FM 15 3000	RD-C07-1	Bronce



Llave con Palanca de 1/2" x 3/4"

Código	REF	Descripción
FM 15 3001	LLA-07	Blister

## LLAVES para Manguera



Llave de Bronce 1/2" x 3/4"

Código	REF	Descripción
FM 15 3002	LLA-73	Cromada

### PRESENTACIÓN



**BLISTER**



**FUNDA**



Llave de Bronce 3/4" x 3/4"

Código	REF	Descripción
FM 16 3004	RD-LLA-102	Bronce



Llave de Bronce 1/2" x 3/4"

Código	REF	Descripción
FM 15 3005	RD-LLA-103	Blister

● FM 15 3005 RD-LLA-103 Blister

● FM 15 3003 RD-LLA-04 Funda

## LLAVES para Manguera



Llave para Manguera 1/2" x 3/4"

Código	REF	Descripción
FM 16 3001	RD-LLA-104	Blister



Llave para Manguera de 3/4" x 3/4"

Código	REF	Descripción
FM 16 3002		Blister

## Llave portacandado

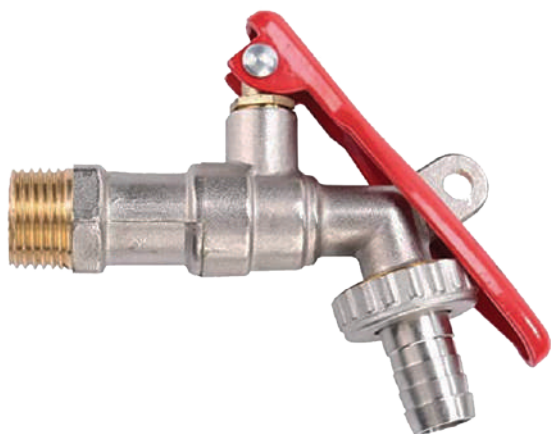

En 2 medidas disponibles:

Código	REF	Descripción
FM153006	LLA-1001	Pared: 1/2" x 1/2"
FM153007	LLA-1002	Pared: 3/4" x 1/2"

## Zapatillas



Para llaves de manguera de 3/4"

Código	Descripción
RIGHI051	3/4"

## Válvulas Swing Check Horizontal H/H



Válvulas Swing Check Horizontal H/H

Código	REF	Descripción
FM 15 5001	VAL-11	1/2"
FM 15 5002	VAL-12	3/4"
FM 15 5003	VAL-13	1"

PREMIUM



ITALY

Chapaleta de Bronce

Válvulas Swing Check Horizontal H/H

Código	Descripción
FM 16 5001	1/2"
FM 16 5002	3/4"
FM 16 5003	1"

## Válvulas Check Vertical H/H



Filtro roscado

FM 15 5091 FIL-01 PARA VAL-01  
 FM 15 5092 FIL-02 PARA VAL-02  
 FM 15 5093 FIL-03 PARA VAL-03

Válvulas check vertical (Filtro Roscado)

Código	REF	Descripción
FM 15 5021	VAL-01	1/2"
FM 15 5022	VAL-02	3/4"
FM 15 5023	VAL-03	1"



Filtro soldado

Válvulas check vertical (Filtro Soldado)

Código	REF	Descripción
FM 15 5011	VAL-50	1/2"
FM 15 5012	VAL-51	3/4"
FM 15 5012	VAL-52	1"

PREMIUM



ITALY

Obturador de Nailon

Válvulas check vertical

Código	Descripción
FM 16 5021	1/2"
FM 16 5022	3/4"
FM 16 5023	1"



## Llaves de bola



Llave de bola cromada

Código	REF	Descripción
FM 15 4001	LLA-21	1/2"
FM 15 4002	LLA-22	3/4"
FM 15 4003	LLA-23	1"
FM 15 4001	LLA-24	1 1/2"
FM 15 4002	LLA-25	2"



Llave de bola niquelada

Código	REF	Descripción
FM 16 4001	LLA-121	1/2"
FM 16 4002	LLA-122	3/4"
FM 16 4003	LLA-123	1"

## Llave de compuerta



Código	REF	Descripción
FM 15 4011	VAL-15	1/2"
FM 15 4012	VAL-16	3/4"

## Filtro recolector



Código	Descripción
FM 16 4021	1/2"
FM 16 4022	3/4"
FM 16 4023	1"



**Válvula bola**

GCO01001 - H 3/8"x H 3/8"

GCO01002 - H 1/2"x H 1/2"

GCO01003 - H 3/4"x H 3/4"



**Válvula bola Manilla Mariposa**

GCO01011 - H 3/8"x H 3/8"

GCO01012 - H 1/2"x H 1/2"

GCO01013 - H 3/4"x H 3/4"



**Válvula bola Manilla Mariposa**

GCO01021 - M 3/8"x H 3/8"

GCO01022 - M 1/2"x H 1/2"

GCO01023 - M 3/4"x H 3/4"

## Válvulas de Gas



**Válvula bola Gas**

GCO02001 - H 3/8"x H 3/8"

GCO02002 - H 1/2"x H 1/2"

GCO02003 - H 3/4"x H 3/4"



**Válvula bola para Gas Manilla Mariposa**

GCO02011 - H 3/8"x H 3/8"

GCO02012 - H 1/2"x H 1/2"

GCO02013 - H 3/4"x H 3/4"



**Válvula bola Manilla Mariposa**

GCO02021 - M 3/8"x H 3/8"

GCO02022 - M 1/2"x H 1/2"

GCO02023 - M 3/4"x H 3/4"

## Protectores eléctricos



Protector para nevera / refrigerador

Código	REF	Descripción
FM 55 0011	PRO-56	110 V



Protector regleta 4 tomas

Código	REF	Descripción
FM 55 0012	PRO-57	110V



Protector para aire acondicionado 220V

Código	REF	Descripción
FM 550013	PRO-58	12000 BTU



Protector para TV

Código	REF	Descripción
FM 55 0014	PRO-59	110V

## Teflones



Teflón de 1/2"

Código	REF	Descripción
FM 55 0001	TEF-01	23FT



Teflón Profesional

Código	REF	Descripción
FM 55 0004	TEF-02	3/4" x 49 FT

## Discos Diamantados



Disco Turbo

Código	REF	Descripción
FM 80 0212	DIS-05	4 1/2"
FM 80 0213	DIS-13	7"



Disco Segmentado

Código	REF	Descripción
FM 80 0201	DIS-03	4 1/2"
FM 80 0202	DIS-11	7"



Disco Continuo

Código	REF	Descripción
FM 80 0203	DIS-04	4 1/2"
FM 80 0211	DIS-12	7"



## Abrazaderas Galvanizadas



Abrazadera para Mangueras

Código	REF	Descripción
FM 50 1603	ABR-22	1/4" a 1/2"
FM 50 1606	ABR-23	9/16" a 1"
FM 50 1609	ABR-24	1 1/8" a 1 1/2"





# Catálogo Rejiplas



[www.fermetal.com](http://www.fermetal.com)



Mueble - Estante para baño  
**Metálico pesado - Blanco**

Mueble - Estante para baño  
**Metálico pesado - Cromado**

Código	REF	Descripción
RJPL0001	10820	Medidas: 63.5 x 34 x 173.6 cm <b>25 x 13.38 x 68.34 pulgadas</b> Capacidad Maxima: 45 lb (15kg por nivel)

Código	REF	Descripción
RJPL0002	10821	Medidas: 63.5 x 34 x 173.6 cm <b>25 x 13.38 x 68.34 pulgadas</b> Capacidad Maxima: 45 lb (15kg por nivel)



Cubiertero  
**para Gaveta**

Código	REF	Descripción
RJPL1001	48481	Medidas: 30 x 43 x 5 cm <b>11.8 x 16.9 x 1.97 pulgadas</b>



Porta champú  
**pequeño cromado**

Código	REF	Descripción
RJPL2001	60009	Medidas: 16.5 x 10 x 48.7 cm <b>6.5 x 3.9 x 19.17 pulgadas</b>

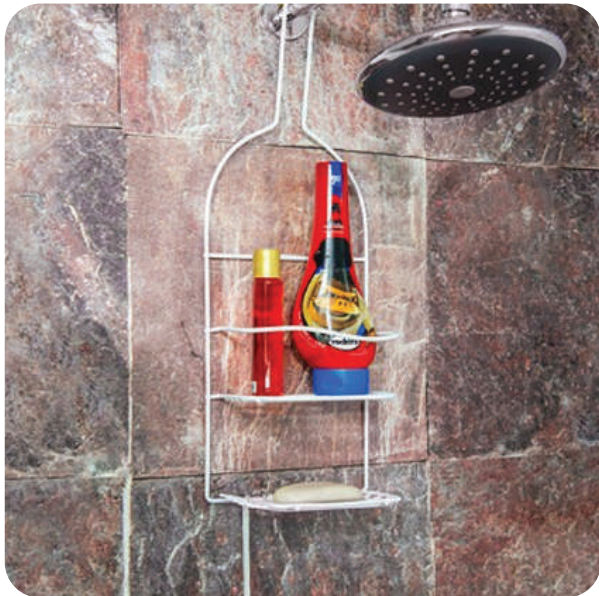

Porta champú  
**pequeño blanco**

Código	REF	Descripción
RJPL2002	60100	-



Porta champú  
**pequeño metalizado**

Código	REF	Descripción
RJPL2003	60101	Medidas: 18 x 11.5 x 50 cm <b>7.8 x 4.52 x 19.6 pulgad</b>



Porta champú  
**Grande metalizado**

Código	REF	Descripción
RJPL2011	60379	Medidas: 29.5 x 9.8 x 70cm <b>11.6 x 3.5 X 27.5 Pulgadas</b>



Porta champú  
**Grande blanco**

Código	REF	Descripción
RJPL2012	60500	Medidas: 26 x 11 x 44 cm <b>10.2 x 4.33 x 17.3 Pulgadas</b>



Porta champú  
**Grande metalizado**

Código	REF	Descripción
RJPL2013	60501	Medidas: 26 x 11 x 44 cm <b>10.2 x 4.33 x 17.3 Pulgadas</b>



Porta jabón  
**Plástico blanco**

Código	REF	Descripción
RJPL3001	98000	Medidas: 14.2x 10.3 x 11 cm <b>4.9 x 4.3 x 12.8 Pulgadas</b>



Set de ganchos de  
**Soporte (Par)**

Código	REF	Descripción
RJPL3002	98010	Medidas: 6.5 x 4.5 x 11.3 cm <b>2.52 x 1.77 x 4.4 Pulgadas</b>





LINEA HOGAR

# ÁREA DE LAVADO



[www.fermetal.com](http://www.fermetal.com)



Lavadero plástico con sistema de instalación

Código	REF	Descripción
MPT80001	-	20" X 13.3" x 8.2"



Lavadero plástico con sistema de instalación

Código	REF	Descripción
MPT80003	-	20" X 13.3" x 8.2"



Lavadero plástico de 24 litros

Código	REF	Descripción
DUR33111	00343	26" x 19" x 14"



Lavadero plástico

Código	REF	Descripción
FM256001	LAV-14	22.5" x 20.5"



Boquillas para lavadero con Sifón extensible

Código	REF	Descripción
FM200501	DES-80	1-1/4"



Boquilla para lavadero con tapón 1-1/2"

Código	REF	Descripción
FM200630	DES-1021	1-1/2" Plástica



Boquilla para lavadero metal-plástico 1-1/2"

Código	REF	Descripción
FM200102	DES-13	Con colaboquilla



Tapón para lavadero



Código	REF	Descripción
DUR33119	00331	Blanca

Facilita la instalación de tu sifón al drenaje lavaderos



Goma reductora

Código	REF	Descripción
FM195001	HYD-PR32	2" x 1/4"
FM195002	HYD-PR40	2" x 1/2"



Llave lavadero tipo  
Florón 1/2" - 3/4"

Código	REF	Descripción
DUR33111	00343	15cm- Incluye adaptador



Grifería multiusos  
para lavadero 1/2" - 3/4"

Código	REF	Descripción
DUR18000	01050	Incluye adaptador



Llave tipo Florón  
1/2" con palanca

Código	REF	Descripción
FM153110	LLA-D106	ABS Cromado



Llave para lavadero  
manilla tripo cruz

Código	REF	Descripción
FM153120	LLA-D2003	ABS- Cromado



Accesorios y Conexiones



Conexión a 90°

Manguera para lavadora

Código	REF	Descripción
DUR81011	09083	3/4" largo 1.80 metros



Accesorios y Conexiones



Válvula para lavadora con manguera macho

Código	REF	Descripción
DUR81010	09086	Incluye válvula



Manguera flexible para desgüe de lavadora

Código	REF	Descripción
FM204901	TUB-30	1" x 1-1/4"



Manguera ABS 3/4" x 3/4" para lavadora

Código	REF	Descripción
FM204803	TUB-31	Largo: 24"
FM204804	TUB-32	Largo: 36"
FM204805	TUB-33	Largo: 48"
FM204806	TUB-34	Largo: 60"



Conexión Yee  
plástica para lavadoras

Código	REF	Descripción
FM403000	YEE-03	1/2" x 3/4" x 3/4"



Conexión Yee  
plástica con llave

Código	REF	Descripción
FM403011	YEE-C02	1/2" x 3/4" x 3/4"



Llave para  
lavadora

Código	REF	Descripción
FM150101	LLA-D20	1/2" x 3/4"



Conexión Yee  
plástica con llave

Código	REF	Descripción
FM403001	YEE-01	1/2"x3/4"



Tapa para registro  
20 x 20 cm

Código	REF	Descripción
TBPL2001	-	20 x 20 cm



Caja para lavadora  
15 x 11 x 7 cm

Código	REF	Descripción
TBPL2011	-	15 x 11 x 7 cm

PAGINA EN CONSTRUCCIÓN

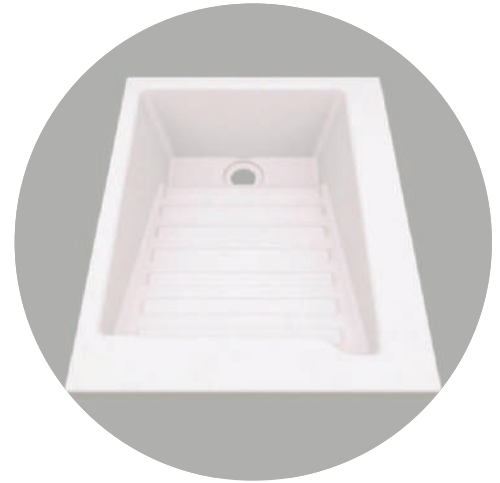

Kit: Lavadero **48x60cm** +  
mueble para lavadero blanco

Código	REF	Descripción
-	-	-



MAMPARAS

DE BAÑO FERMETAL



[www.fermetal.com](http://www.fermetal.com)





Mampara transparente  
**3/8" Altura: 1.90 cm**

Código	REF	Descripción
FM311001	SHS-001	Ancho : 80 cm
FM311002	SHS-002	Ancho : 90 cm
FM311003	SHS-003	Ancho : 100 cm



Mampara con diseño de rayas  
**3/8" Altura: 1.90 cm**

Código	REF	Descripción
FM311011	SHS-011	Ancho : 80 cm
FM311012	SHS-012	Ancho : 90 cm
FM311013	SHS-013	Ancho : 100 cm

CONVIERTE TU MAMPARA  
**EN COLOR NEGRO**



CON EL GANCHO Y EL PORTA TOALLA



Mampara con portatoalla y diseño de rayas **3/8"** Altura: **1.90 cm**

Código	REF	Descripción
FM311021	SHS-021	Ancho : 80 cm
FM311022	SHS-022	Ancho : 90 cm
FM311023	SHS-023	Ancho : 100 cm

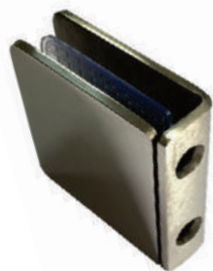

Gancho recto de Acero Inoxidable para instalación

Código	REF	Descripción
FM311080	SHS-901	Gancho Recto



Gancho de 90° de Acero Inoxidable para instalación

Código	REF	Descripción
FM311081	SHS-902	Gancho de 90°



Gancho de 90° de Acero Inoxidable para instalación

Código	REF	Descripción
FM311083	SHS-903	Gancho de 90°



Porta toalla ovalado 45 cm

Código	REF	Descripción
FM311090	SHS-911	Para SCH-021 / 022 / 023



Porta toalla cuadrado 45 cm

Código	REF	Descripción
FM311091	SHS-912	Para SCH-021 / 022 / 023



Porta toalla cuadrado negro de 45 cm

Código	REF	Descripción
FM311093	SHS-914	Para SCH-021 / 022 / 023



ESPEJOS DE

# BAÑO FERMETAL



[www.fermetal.com](http://www.fermetal.com)

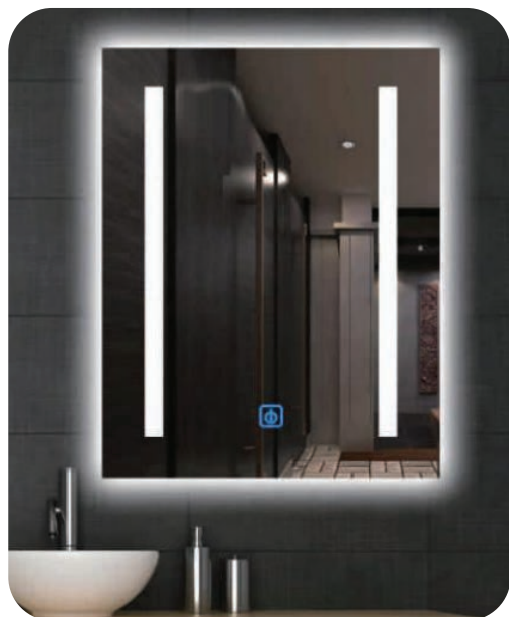

Espejo Led **Vertical**  
Medidas: 31.5 x 23.5 " pulgadas

Código	REF	Descripción
FM310001	LED-905	Medidas: 80 x 60 cm



Espejo Led **Vertical**  
Medidas: 31.5 x 23.5 " pulgadas

Código	REF	Descripción
FM310002	LED-907	Medidas: 80 x 60 cm

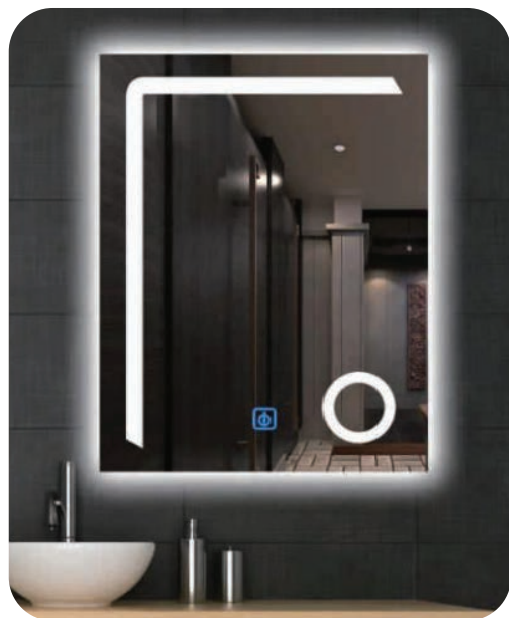

Espejo Led **Vertical**  
Medidas: 31.5 x 23.5 " pulgadas

Código	REF	Descripción
FM310003	LED-916	Medidas: 80 x 60 cm

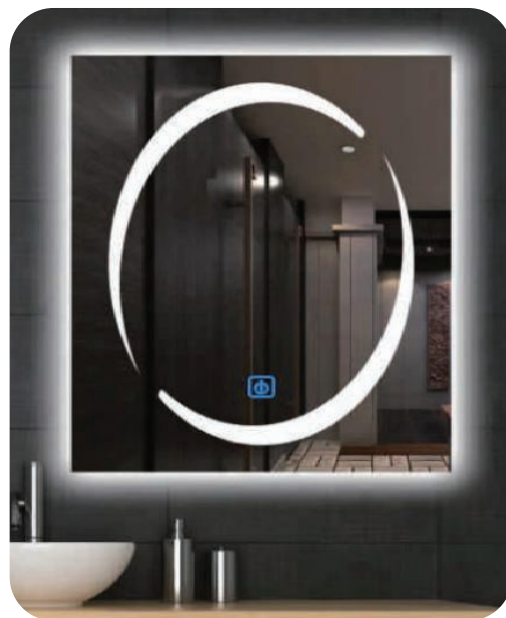

Espejo Led **Vertical**  
Medidas: 31.5 x 23.5 " pulgadas

Código	REF	Descripción
FM310004	LED-919	Medidas: 80 x 60 cm



Espejo Led **Vertical**  
Diámetro: 23.5" pulgadas

Código	REF	Descripción
FM310030	LED-950	Diámetro: 60 cm



Espejo Led **Horizontal**  
Medidas: 23.5 x 31.5" pulgadas

Código	REF	Descripción
FM310051	LED-1102	Medidas: 60 x 80 cm

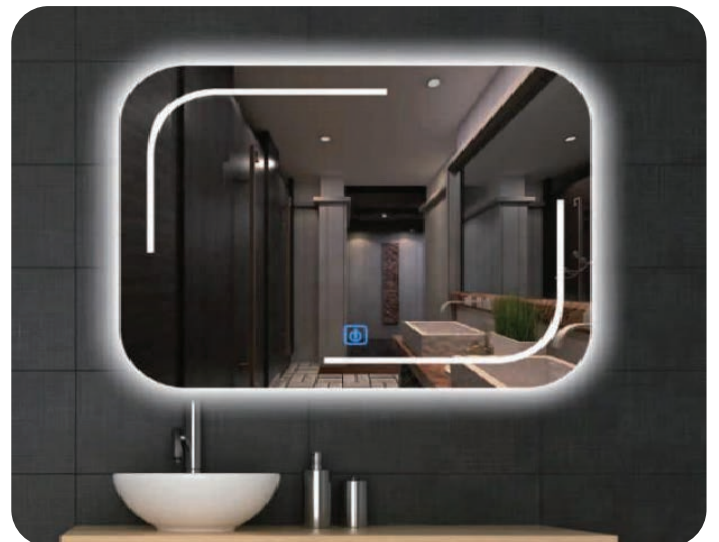

Espejo Led **Horizontal**  
Medidas: 23.5 x 31.5" pulgadas

Código	REF	Descripción
FM310050	LED-1097	Medidas: 60 x 80 cm



# SANITARIOS

Inodoros y Lavamanos



[www.fermetal.com.do](http://www.fermetal.com.do)

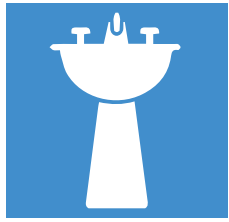

FERMETAL PREMIUM



Código	REF	Descripción
FM305212	LAV-110	Medidas: 20" x 18" x 33" Pulgadas



Código	REF	Descripción
FM305213	LAV-111	Medidas: 22" x 18" x 34" Pulgadas



Código	REF	Descripción
FM305214	LAV-112	Medidas: 21" x 18" x 33" Pulgadas



Código	REF	Descripción
FM305215	LAV-1113	Medidas: 23" x 18" x 34" Pulgadas



Código	REF	Descripción
FM301011	LAV-03	Lavamanos tipo taino 1 hueco, 16" x 27" inch



Código	REF	Descripción
FM301002	LAV-02	Lavamanos sin pedestal 1 hueco, 16" inch



Código	REF	Descripción
FM301003	PEDE-01	Pedestal blanco 27" inch



Código	REF	Descripción
FM301015	LAV-06	Lavamanos de 20" 1 hueco



Código	REF	Descripción
FM301016	LAV-04	Lavamanos de 20" 3 huecos





FERMETAL PREMIUM



Desagüe  
Washdown

Código	REF	Descripción
FM305012	IND-101	Inodoro Washdown Medidas: 68 x 38 x 67 cm



Desagüe  
Sifónico

Código	REF	Descripción
FM305017	IND-106	Inodoro Sifónico Medidas: 22 x 36 x 75 cm



Desagüe  
Sifónico

Código	REF	Descripción
FM305019	IND-108	Inodoro Sifónico Medidas: 69 x 41 x 60 cm



Desagüe  
Washdown

Código	REF	Descripción
FM305018	IND-107	Inodoro Washdown Medidas: 68 x 38.5 x 78 cm



FERMETAL PREMIUM



Desagüe  
Washdown



Desagüe  
Sifónico

Código	REF	Descripción
FM305013	IND-102	Inodoro bajo Medidas: 72 x 39 x 65 cm

Código	REF	Descripción
FM305020	IND-109	Inodoro Sifónico Medidas: 72 x 39 x 77 cm



Desagüe  
Washdown



Super descarga 4D



Desagüe  
Washdown

Código	REF	Descripción
FM305014	IND-103	Wash down Toilet Medidas: 74.5 x 41.5 x 72 cm

Código	REF	Descripción
FM305015	IND-104	Super descarga 4D Medidas: 70.5 x 39 x 75 cm

Código	REF	Descripción
FM305016	IND-105	Descarga Washdown Medidas: 69 x 41 x 83 cm



Código	REF	Descripción
FM305021	IND-110	Tanque Alto Elongado



Código	REF	Descripción
FM300000	<b>SAN-36</b>	Inodoro Push button 2 piezas



Código	REF	Descripción
FM300003	<b>IND-07</b>	Inodoro con balancín 2 piezas



Código	REF	Descripción
FM300001	<b>IND-01</b>	Inodoro con balancín 2 piezas, pequeño.



Código	REF	Descripción
FM300002	<b>IND-02</b>	Inodoro 2 piezas Push Button



28"



## URINARIO

Código	REF	Descripción
FM305100	URI-01	Medidas: 19" x 12" x 28" pulgadas



# INODOROS Y LAVAMANOS

(Sobreponer y con pedestal)



FM305022 - **IND-111**  
INODORO ONE PIECE TANQUE BAJO  
**NEGRO**



FM305216 - **LAV-114**  
LAVAMANOS CON PEDESTAL 62 x 46 x 83cm  
**NEGRO**



FM305322 - **LAV-221**  
LAVAMANOS REDONDO DE SOBREPONER  
42 X 13 CM **NEGRO**



FM305023 - **IND-112**  
INODORO ONE PIECE TANQUE BAJO  
**MARFIL**



FM305217 - **LAV-115**  
LAVAMANOS CON PEDESTAL 62x 46 x 83cm  
**MARFIL**



FM305323 - **LAV-222**  
LAVAMANOS REDONDO DE SOBREPONER  
42 X 13 CM **MARFIL**



FM305024 - **IND-113**  
INODORO ONE PIECE TANQUE ALTO  
**VERDE - DORADO**



FM305216 - **LAV-116**  
LAVAMANOS CON PEDESTAL 62x 46 x 83cm  
**VERDE - DORADO**



FM305324 - **LAV-223**  
LAVAMANOS REDONDO DE SOBREPONER  
42 X 13 CM **MARFIL**

# INODOROS Y LAVAMANOS

(Sobreponer y con pedestal)



FM305025 - **IND-114**  
INODORO ONE PIECE TANQUE MEDIO  
**GRIS - DORADO**



FM305219 - **LAV-117**  
LAVAMANOS CON PEDESTAL 62x 46 x 83cm  
**GRIS- DORADO**



FM305325 - **LAV-224**  
LAVAMANOS REDONDO DE SOBREPONER  
42 X 13 CM **GRIS**



FM3050256 - **IND-115**  
INODORO ONE PIECE TANQUE MEDIO  
**BLANCO Y NEGRO**



FM305220 - **LAV-118**  
LAVAMANOS CON PEDESTAL 62x 46 x 83cm  
**NEGRO - BLANCO**



FM305326 - **LAV-225**  
LAVAMANOS REDONDO DE SOBREPONER  
42 X 13 CM **NEGRO - BLANCO**

# INODOROS Y LAVAMANOS

(Sobreponer y con pedestal)



**FM305028 -IND-117**  
INODORO ONE PIECE TANQUE MEDIO  
**AZUL- DORADO**



**FM305222 -LAV-120**  
LAVAMANOS CON PEDESTAL 62x 46 x 83cm  
**AZUL- DORADO**



**FM305328 -LAV-227**  
LAVAMANOS REDONDO DE SOBREPONER  
42 X 13 CM **AZUL-DORADO**



**FM305024 -IND-116**  
INODORO ONE PIECE TANQUE MEDIO  
**BLANCO Y DORADO**



**FM305221 -LAV-119**  
LAVAMANOS CON PEDESTAL 62x 46 x 83cm  
**BLANCO Y DORADO**



**FM305327 -LAV-226**  
LAVAMANOS REDONDO DE SOBREPONER  
42 X 13 CM **BLANCO - DORADO**



# LAVAMANOS ONE PIECE



**FM305201 - LAV-401**  
LAVAMANOS ONE PIECE REDONDO  
**49 X 82 CM**



**FM305202 - LAV-402**  
LAVAMANOS ONE PIECE CUADRADO  
**47.5 X 83 CM**



**FM305203 - LAV-403**  
LAVAMANOS ONE PIECE REDONDO  
**45 X 85 CM**

**\*NO INCLUYEN GRIFERÍA\***

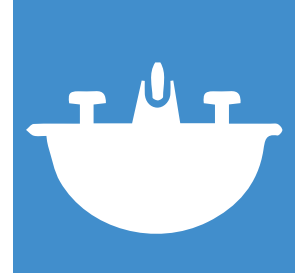

# LAVAMANOS DE SOBREPONER



**FM305301 - LAV-200:**  
LAVAMANOS REDONDO  
**40x14cm** BLANCO



**FM305302 - LAV-201:**  
LAVAMANOS REDONDO  
**46x16cm** BLANCO



**FM305303 - LAV-202:**  
LAVAMANOS REDONDO  
**43x17cm** BLANCO



**FM305304 - LAV-203:**  
LAVAMANOS CUADRADO  
**38x13cm** BLANCO



**FM305305 - LAV-204:**  
LAVAMANOS CUADRADO  
**41x15cm** BLANCO



**FM305306 - LAV-205:**  
LAVAMANOS RECTANGULAR  
**56x45x15cm** BLANCO

# LAVAMANOS DE SOBREPONER

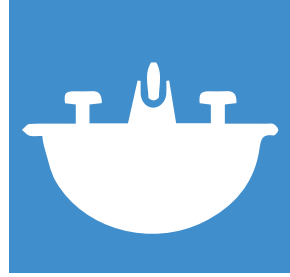

**FM305307 - LAV-206:**  
LAVAMANOS RECTANGULAR  
**48x37x13cm** BLANCO



**FM305308 - LAV-207:**  
LAVAMANOS OVALADO  
**63x42x12 cm** BLANCO



**FM305309 - LAV-208:**  
LAVAMANOS RECTANGULAR  
**44x34x12cm** BLANCO



**FM305310 - LAV-209:**  
LAVAMANOS RECTANGULAR  
**57.5x38x11.5cm** BLANCO



**FM305311 - LAV-210:**  
LAVAMANOS ESTRELLA  
**40x13cm** BLANCO



**FM305312 - LAV-211:**  
LAVAMANOS REDONDO TEXTURIZADO  
**46x15.5cm** BLANCO

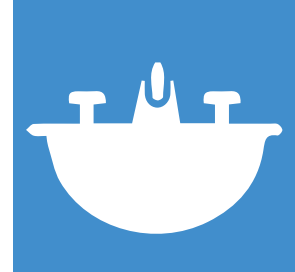

# LAVAMANOS DE SOBREPONER



**FM305313 - LAV-212**  
LAVAMANOS RECTANGULAR TEXTURIZADO  
**48 x 37 x 13cm** BLANCO



**FM305314 - LAV-213:**  
LAVAMANOS RECTANGULAR  
**50.5x37x13 cm** NEGRO



**FM305315 - LAV-214:**  
LAVAMANOS OVALADO  
**50x40x15cm** NEGRO



**FM305316 - LAV-215:**  
LAVAMANOS REDONDO  
**40 x 14 cm** BLANCO  
/NEGRO



**FM305317 - LAV-216:**  
LAVAMANOS CUADRADO  
**38.5 X 14 cm** NEGRO



**FM305318 - LAV-217:**  
LAVAMANOS OVALADO DORADO  
**46x15.5cm** BLANCO

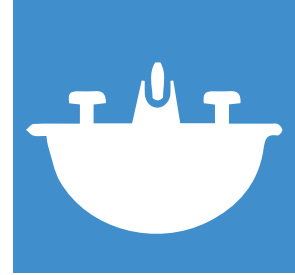

# LAVAMANOS DE SOBREPONER



**FM305319 - LAV-218:**  
LAVAMANOS OVALADO CROMADO  
**50 X 31 X 15 cm**



**FM305320 - LAV-219:**  
LAVAMANOS REDONDO  
**41.5 X 13.5 cm**  
BLANCO/DORADO



**FM305321 - LAV-220**  
LAVAMANOS OVALADO  
**40x 33 x 14.5 cm**  
CROMADO

**NOTA:**  
NO INCLUYEN GRIFERIA, LAS FOTOGRAFIAS SON REFERENCIAL

# BAÑERAS E HIDROMASAJES

---



unique

---

[www.fermetal.com.do](http://www.fermetal.com.do)





## Bañera Ovalada

Blanca Código: UQ405001

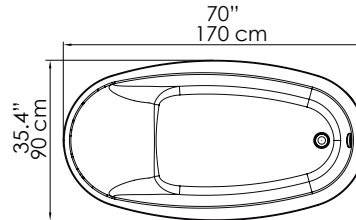

VISTA SUPERIOR / UPPER VIEW

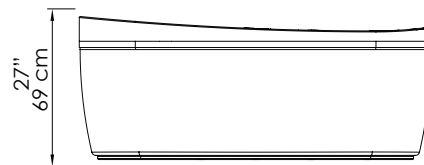

VISTA LATERAL / LATERAL VIEW



Capacidad de agua:  
302 Litros  
79.7 Galones



Puedes añadir el monomando para bañera con ducha de mano redonda

GRI-8001



## Bañera Ovalada con grifería, ducha y cascada

Código: UQ405002

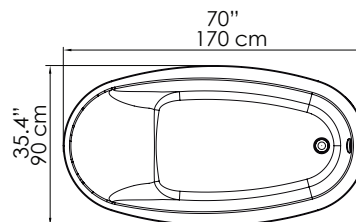

VISTA SUPERIOR / UPPER VIEW

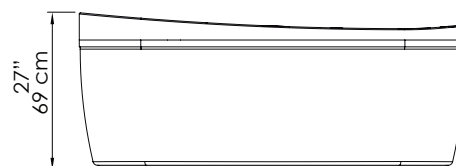

VISTA LATERAL / LATERAL VIEW



Capacidad de agua:  
302 Litros  
79.7 Galones

# unique



## Hidromasaje Ovalado con grifería, ducha y cascada

Código: UQ405003

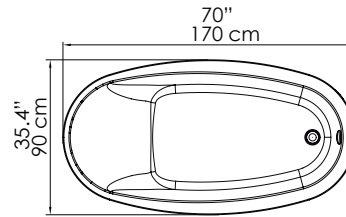

VISTA SUPERIOR / UPPER VIEW

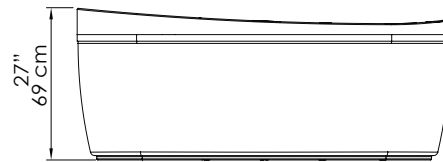

VISTA LATERAL / LATERAL VIEW



Capacidad de agua:  
302 Litros  
79.7 Galones



Puedes añadir  
mantenedor  
de temperatura



Hidroterapia



Cromoterapia



Panel  
Digital



Kit  
Teleducha



## Hidromasaje Redondo con grifería, ducha y cascada

Código: UQ405012

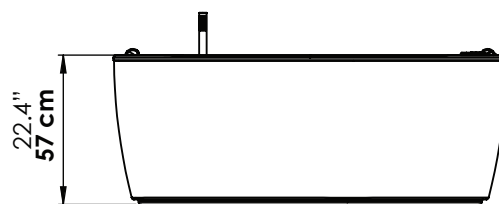

VISTA LATERAL / LATERAL VIEW

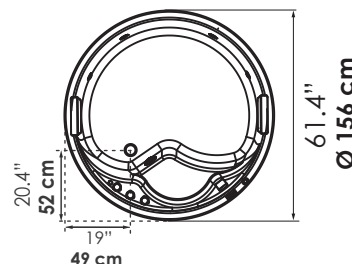

VISTA SUPERIOR / UPPER VIEW



Capacidad de agua:  
384 Litros  
101.4 Galones



Puedes añadir  
mantenedor  
de temperatura



Hidroterapia



Cromoterapia



Panel  
Digital







Kit  
Teleducha



Puedes añadir tu mantenedor  
de temperatura M15 a tu Hidromasaje  
Código: UQ405091





-   
Hidroterapia
-   
Cromoterapia
-   
Panel Digital
-   
Kit Teleducha

## Hidromasaje Lateral Derecho

Código: UQ405021

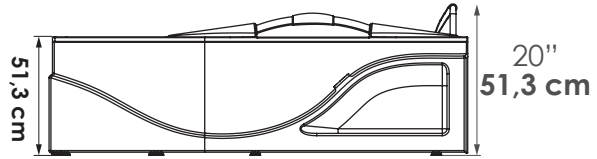

VISTA LATERAL / LATERAL VIEW

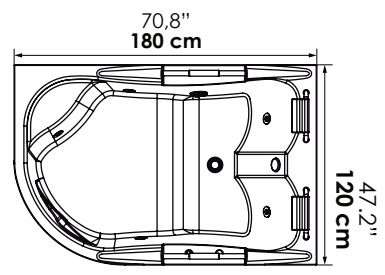

VISTA SUPERIOR / UPPER VIEW

-  **Capacidad de agua:**  
320 Litros  
70.4 Galones
-  **Puedes añadir**  
mantenedor de temperatura
-  **Recomendado para**  
2 personas



-   
Hidroterapia
-   
Cromoterapia
-   
Panel Digital
-   
Kit Teleducha

## Hidromasaje Lateral Izquierdo

Código: UQ405022

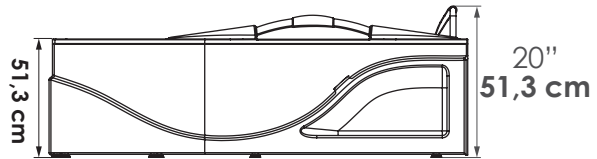

VISTA LATERAL / LATERAL VIEW

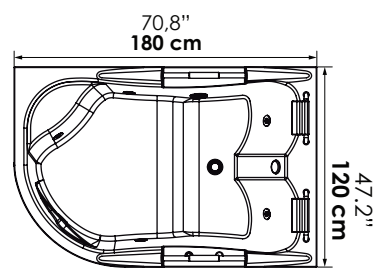

VISTA SUPERIOR / UPPER VIEW

-  **Capacidad de agua:**  
320 Litros  
70.4 Galones
-  **Puedes añadir**  
mantenedor de temperatura
-  **Recomendado para**  
2 personas



**Puedes añadir tu mantenedor de temperatura M15 a tu Hidromasaje**  
Código: UQ405091



-   
Hidroterapia
-   
Cromoterapia
-   
Panel Digital
-   
Kit Teleducha

## Hidromasaje Esquinero

Código: UQ405031

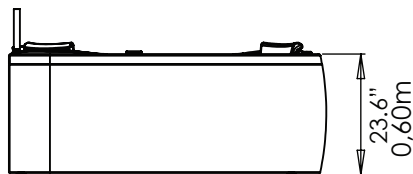

VISTA LATERAL / LATERAL VIEW

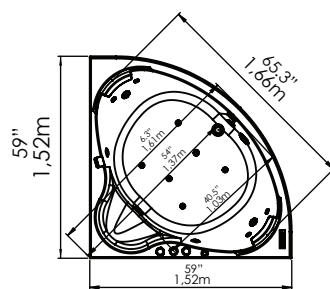

VISTA SUPERIOR / UPPER VIEW



Capacidad de agua:  
500 Litros  
132 Galones



Puedes añadir  
mantenedor  
de temperatura



Recomendado para  
2 personas



-   
Hidroterapia
-   
Cromoterapia
-   
Panel Digital
-   
Kit Teleducha

## Spa - 4 Personas Incluye deck de madera

Código: UQ405041

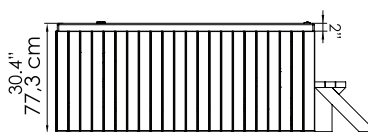

VISTA LATERAL / LATERAL VIEW

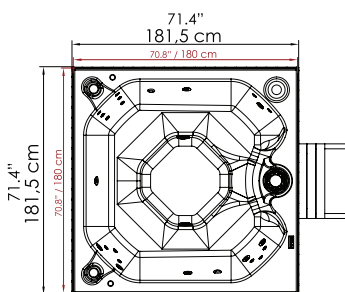

VISTA SUPERIOR / UPPER VIEW



Capacidad de agua:  
850 Litros  
224 Galones

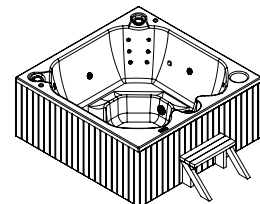

VISTA ISOMETRICA / ISOMETRIC VIEW



Recomendado para  
4 personas



Puedes añadir tu mantenedor  
de temperatura M55 para  
este Spa para 4 personas  
Código: UQ405092



MUEBLES DE

# BAÑO FERMETAL



[www.fermetal.com](http://www.fermetal.com)

**Espejo:**

Ancho: 40 cm Altura: 50 cm



Mueble de baño  
Blanco y negro 48x 37 cm

Código	REF	Descripción
FM306100	MUE-500	Lavamanos + Espejo

**Espejo:**

Ancho: 40 cm Altura: 50 cm



Mueble de baño  
Blanco y negro 48x 37 cm

Código	REF	Descripción
FM306101	MUE-501	Lavamanos + Espejo



**Materiales:**

Melamina Hidrófuga

**Espejo:**

Diámetro: 60 cm

Mueble de baño  
**60 x 46 x 48 cm**

Código	REF	Descripción
FM306103	MUE-503	Lavamanos + Espejo



**Materiales:**

MDF hidrófugo  
laqueado

**Espejo:**

Ancho: 45 cm  
Alto: 60 cm



Mueble de baño  
**41 x 28 x 48 cm**

Código	REF	Descripción
FM306102	MUE-502	Lavamanos + Espejo



**Materiales:**

MDF hidrófugo  
laqueado, tope de  
cuarzo sintético

**Espejo:**

Ancho: 60 cm  
Alto: 80 cm



Mueble de baño  
**59 x 47 x 48 cm**

Código	REF	Descripción
FM306104	MUE-504	Lavamanos + Espejo

CATÁLOGO  
**BAÑOS**

---



unique







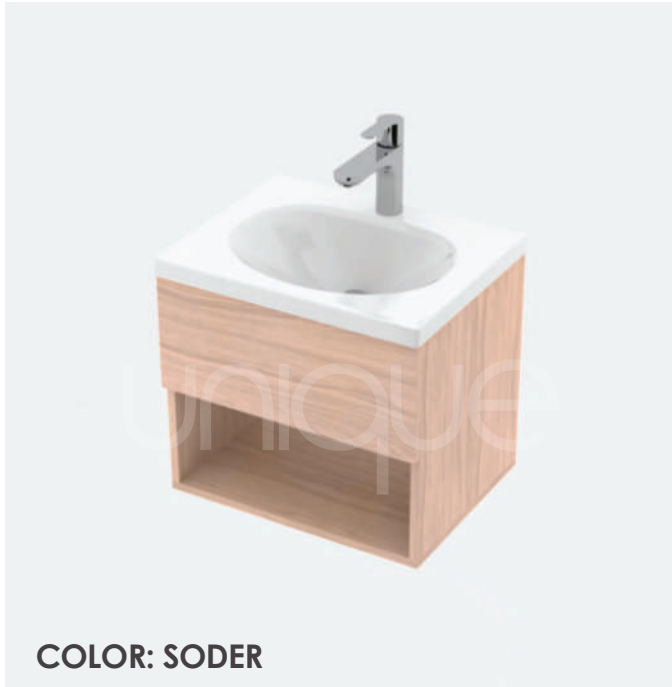





---

[www.fermetal.com.do](http://www.fermetal.com.do)





## Mueble Básico

Códigos	Mueble Básico	INCLUYE
 UQ800001 <b>MUE-0001</b>  UQ800003 <b>MUE-0003</b>	 + para Lavamanos de <b>40x30cm</b>	Lavamanos 40x30cm - 15.7"x 11.8"  Redondo
 UQ800011 <b>MUE-0011</b>  UQ800013 <b>MUE-0013</b>	 + Para Lavamanos de <b>48x38cm</b>	Lavamanos 48x38cm - 19"x15"  Redondo
 UQ800021 <b>MUE-0021</b>  UQ800023 <b>MUE-0023</b>	 + Para Lavamanos de <b>63x48cm</b>	Lavamanos 63x48cm - 25"x19"  Ovalado



Soder  
**0437**



Mitte  
**0439**









### Caraterísticas:



Aglomerado de 15 mm



## Mueble Básico 2 Puertas

Códigos	Muebles Básicos Elevados	INCLUYE
 UQ800031 MUE-0111  UQ800033 MUE-0113	 + para Lavamanos de <b>48x43cm</b>	Lavamanos 48x38cm - 19"x 15"  Redondo
 UQ800041 MUE-0121  UQ800043 MUE-0123  UQ800044 MUE-0124	 + Para Lavamanos de <b>63x48cm</b>	Lavamanos 63x48cm - Sinks 25"x19"  Ovalado

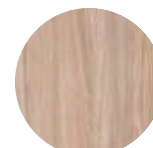

Soder  
0437

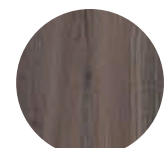

Mitte  
0439



Carbono  
0447

### Caraterísticas muebles

Disponibile en:



Cierre lento



Aglomerado de 15 mm





COLOR: MITTE

COLOR: SODER



COLOR: MITTE

## Mueble Básico de Piso

### Caraterísticas muebles



Cierre lento



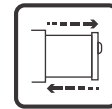

Patas regulables

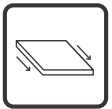

Cubo cajón Riel Full



Entrepaño Móvil

Códigos	Muebles Básico Piso	AÑADE
 UQ800081 MUE-0301	 para Lavamanos de <b>40x30cm</b>	Lavamanos 40x30cm - 16"x 12"  Redondo
 UQ800091 MUE-0311  UQ800093 MUE-0313	 Para Lavamanos de <b>48x38cm</b>	Lavamanos 48x38 cm - Sinks 19"x15"  Redondo



Soder  
**0437**



Mitte  
**0439**



COLOR: MITTE

## Caraterísticas muebles



Cierre lento

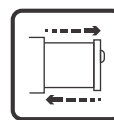

Cubo cajón Riel Full



Frente de cajón con canto 15 mm

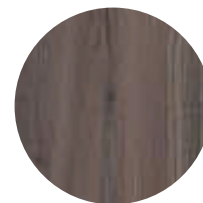

Mitte  
0439



Carbono  
0447

## Muebles 3 Gavetas Elevados

Códigos	Muebles 3 Gavetas	INCLUYE
 UQ800153 MUE-0723  UQ800154 MUE-0724	 +	Lavamanos 63x48cm -25"x 19"  Cuadrado
 UQ800183 MUE-0753  UQ800184 MUE-0754	 +	Cuadrado <b>LAVAMANOS DOBLE</b>



COLOR: MITTE



COLOR: CARBONO



COLOR: MITTE

## Características muebles



Cierre lento

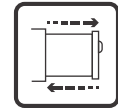

Cubo cajón  
Riel Full extension  
cierre suave



Frente de cajón  
con canto 2mm

## Muebles De Luxe 3 Gavetas

Códigos	Muebles De Luxe 3 gavetas	INCLUYE
 UQ800213 MUE-0923	 +	Lavamanos 63x48cm -25"x 19"  Cuadrado
 UQ800214 MUE-0924	para Lavamanos de <b>63x48cm</b>	
 UQ800223 MUE-0933	 +	 Cuadrado
	para Lavamanos de <b>79x48cm</b>	

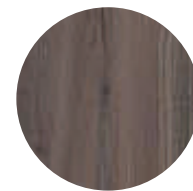

Mitte  
0439



Carbono  
0447



COLOR: CARBONO



Mueble KIT

## Japonés a piso

### Características muebles



Aglomerado de 15 mm



Frente de cajón con canto 2mm

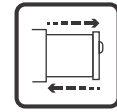

Cubo cajón Riel Full extension cierre suave



Toallero integrado en estructura

Códigos	Muebles Japonés piso	INCLUYE
UQ800311 MUE-1315	<p>Mueble con entropaño para Lavamanos de <b>48x43cm</b></p>	<p>Lavamanos 48x43 cm - 19"x17"</p> <p>Cuadrado</p>
UQ800312 MUE-1325	<p>Mueble con entropaño para Lavamanos de <b>63x48cm</b></p>	<p>Lavamanos 79x48 cm - Sinks 31"x19"</p> <p>Cuadrado</p>



Solo disponible en Tribeca **0458**

Inspírate con algunas ideas, deja volar tu imaginación con más de 100 combinaciones.

Algunas combinaciones **japones a piso**

Algunas combinaciones **japones elevado**

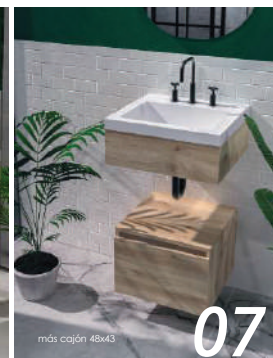
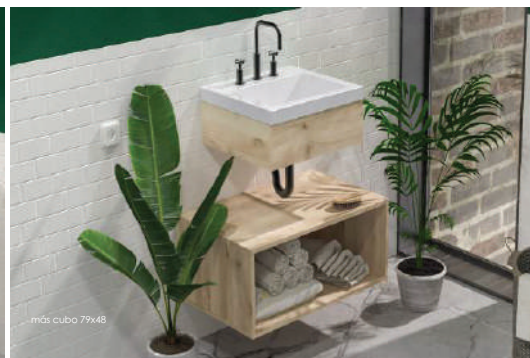



## Caraterísticas muebles



Aglomerado de 15 mm



Cubo cajón Riel Full extension cierre suave









Frente de cajón con canto 2mm



Solo disponible en Tribeca 0458

Mueble KIT

## Japonés elevado

Códigos	Muebles Japonés Elevados	INCLUYE
UQ800321 MUE-1415	  Para Lavamanos de <b>48x43cm</b>	<p>Lavamanos 48x43 cm - 19"x17"</p>  <p>Cuadrado</p>
UQ800322 MUE-1425	  Para Lavamanos de <b>63x48cm</b>	<p>Lavamanos 79x48 cm - Sinks 31"x19"</p>  <p>Cuadrado</p>

### Complementa tu mueble Japonés con estas diferentes opciones

<b>Códigos</b> UQ800331 MUE-1515	 <p>Cubo 48x43cm</p>	<b>Códigos</b> UQ800333 MUE-1615	 <p>*Cubo cajón 48x43cm</p>
<b>Códigos</b> UQ800332 MUE-1525	 <p>Cubo 63x48cm</p>	<b>Códigos</b> UQ800334 MUE-1625	 <p>*Cubo cajón 63x48cm</p>



## Caraterísticas

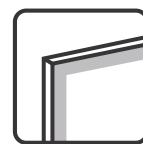

Espejo con borde matizado

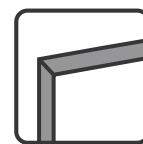

Aglomerado de 15 mm

## Gabinetes

Disponible en:



Blanco

**GAB-0110**  
UQ800540

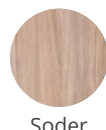

Soder  
0437

**GAB-0111**  
UQ800541

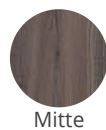

Mitte  
0439

**GAB-0113**  
UQ800543

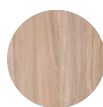

Soder  
0437

**GAB-0121**  
UQ800551

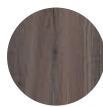

Mitte  
0439

**GAB-0123**  
UQ800553



Gabinete superior  
40x60 cm / 15.7"x23.6"



Gabinete superior  
60x60 cm / 23.6"x23.6"



## Caraterísticas

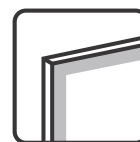

Espejo con borde  
matizado

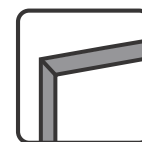

Aglomerado  
de 15 mm

Espejos con marco

Disponible en:

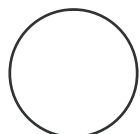

Blanco

**ESP-0010**  
UQ800500

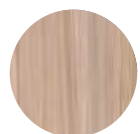

Soder  
**0437**

**ESP-0011**  
UQ800501

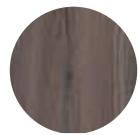

Mitte  
**0439**

**ESP-0013**  
UQ800503



Tribeca

**ESP-0015**  
UQ800505

## Espejo con marco



Espejo con marco  
48x63 cm / 18,9"x24.8"



Diagrama de instalación

## Tornillos para tanque

Código	REF	Descripción
FM 30 9001	<b>TOR-01</b>	Material: Bronce

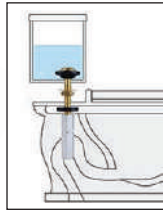

Diagrama de instalación

## Tornillos para tanque

Código	REF	Descripción
FM 30 9002	<b>TOR-02</b>	Material: PVC

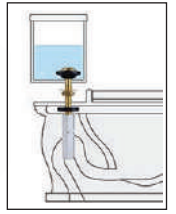

Diagrama de instalación

## Tornillos para fijación

Código	REF	Descripción
FM 30 9003	<b>TOR-04</b>	Material: Bronce

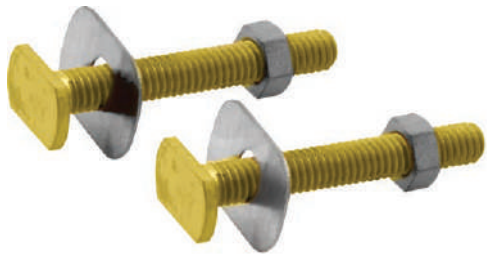

Diagrama de instalación

## Tornillos para fijación

Código	Descripción
BS 00 0101	Acero anticorrosivo 5/16" x 2-1/4"



## Tapitas cubretornillos

Código	REF	Descripción
BS 00 0201	-	Blanca



## Anillo para fijación al piso

Código	Descripción
BS 00 0301	Para desagüe de 4"



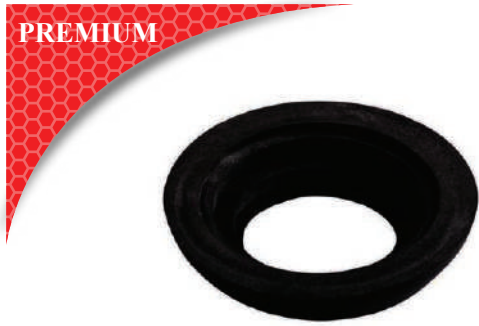

PREMIUM

Junta de entronque

Código	REF	Descripción
FM 30 9011	<b>EMP-03</b>	Para Inodoros de 2"



PREMIUM

Junta de entronque

Código	REF	Descripción
FM 30 9012	<b>EMP-04</b>	Para Inodoros de 3"



Anillo de cera

Código	REF	Descripción
FM 30 9051	<b>WAX-01</b>	-



Anillo de cera con flange

Código	REF	Descripción
FM 30 9052	<b>WAX-02</b>	-



Anillo de cera

Código	REF	Descripción
BS 00 0001	-	Made in Usa



Anillo de cera con flange

Código	REF	Descripción
BS 00 0011	-	Made in Usa



Filtro para válvula de llenado para Inodoro 1/2"

Código	REF	Descripción
FM 30 9016	<b>FIL-100</b>	Hembra x Macho



Adaptador para válvula de llenado

Código	REF	Descripción
FM 30 9017	<b>FIL-101</b>	Hembra: 1/2" Macho: 7/8"



Flapper

Código	REF	Descripción
FM 30 9021	<b>CHA-01</b>	Entrada: 2"
FM 30 9023	<b>FLA-06</b>	Entrada: 3"



Flapper de silicón

Código	REF	Descripción
FM 30 9022	<b>FLA-01</b>	Entrada: 2"



Destupidor de 6"

Código	REF	Descripción
FM 30 9041	<b>DES-52</b>	Mango plástico



Destupidor profesional de 5"

Código	REF	Descripción
FM 30 9045	-	Mango madera



Balancín de Bronce

Código	REF	Descripción
FM 30 9031	<b>BAL-02</b>	Manilla Metálica



Balancín Plástico Cromado

Código	REF	Descripción
FM 30 9032	<b>BAL-03</b>	*Repuesto*



Balancín Metálico

Código	REF	Descripción
FM 30 9033	<b>BAL-100</b>	Cromado



Botón para Inodoro

Código	REF	Descripción
FM 30 9035	<b>BAL-004</b>	*Repuesto*

Botones para Inodoros

Código	REF	Descripción
FM 30 9061	<b>BOT-100</b>	Sencillo Ø 38 mm
FM 30 9062	<b>BOT-101</b>	Doble Ø 48 mm
FM 30 9063	<b>BOT-102</b>	Doble Ø 58 mm



PREMIUM



Botón rectangular para doble descarga

Código	REF	Descripción
FM309064	<b>BOT-103</b>	83 mm x 46mm



Botón ovalado para doble descarga

Código	REF	Descripción
FM309065	<b>BOT-104</b>	99mm x 28mm



Botón cuadrado para doble descarga

Código	REF	Descripción
FM309066	<b>BOT-105</b>	72mm x 72mm



Botón cuadrado para doble descarga

Código	REF	Descripción
FM309067	<b>BOT-106</b>	79mm x 44mm



Válvula de llenado económica

Código	REF	Descripción
FM309109	<b>VAL-63</b>	Para baja presión



Válvula de llenado baja presión

Código	REF	Descripción
FM309102	<b>VAL-202</b>	Entrada: Macho 1/2"



Válvula de llenado con boya

Código	REF	Descripción
FM309101	<b>VAL-201</b>	Entrada: Macho 1/2"



Válvula de llenado para agua turbia

Código	REF	Descripción
FM309103	<b>VAL-200</b>	Altura Graduable

## Válvulas de Descarga



Código	REF	Descripción
FM309201	<b>VAL-208</b>	Inodoro 2 piezas Desagüe <b>2"</b>



Código	REF	Descripción
FM309202	<b>VAL-209</b>	Inodoro One Piece Desagüe <b>2"</b>



Código	REF	Descripción
FM309203	<b>VAL-210</b>	Inodoro 2 piezas Desagüe <b>3"</b>



Código	REF	Descripción
FM309204	<b>VAL-211</b>	Inodoro One Piece Desagüe <b>3"</b>

**3 años de Garantía**

**3 años de Garantía**

## Válvulas de descarga Dual



Código	REF	Descripción
FM309221	<b>VAL-203</b>	Para inodoro 2 piezas Desagüe <b>2"</b>

Código	REF	Descripción
FM309225	<b>VAL-204</b>	Para inodoro One Piece Desagüe <b>2"</b>

Código	REF	Descripción
FM309226	<b>VAL-205</b>	Para inodoro One Piece Desagüe <b>2"</b>



Código	REF	Descripción
FM309231	<b>VAL-206</b>	Para inodoro 2 piezas Desagüe <b>3"</b>

Código	REF	Descripción
FM309236	<b>VAL-207</b>	Para inodoro One Piece Desagüe <b>3"</b>

## Kits para Inodoros



Kit para Inodoro Push button  
Vávula de entrada 1/2" + Desagüe 2"

Código	REF	Descripción
FM 30 9301	<b>VAL-65</b>	Desagüe 2"



Kit para Inodoro Balancín  
Vávula de entrada 1/2" + Desagüe 3"

Código	REF	Descripción
FM 30 9302	-	Desagüe 3"



## Asientos para Inodoros



Código	REF	Descripción
FM 30 9400	<b>TAP-003</b>	Redonda Blanca



Código	REF	Descripción
FM 30 9401	<b>TAP-001</b>	Elongada Blanca



Código	REF	Descripción
FM 30 9402	<b>TAP-002</b>	Redonda blanca



Código	REF	Descripción
FM 30 9403	<b>TAP-004</b>	Elongada Blanca



Accesorios y Conexiones



Código	REF	Descripción
DUR31001	<b>00662</b>	Redonda blanca



Accesorios y Conexiones



Código	REF	Descripción
DUR31002	<b>00664</b>	Redonda Beige



Código	REF	Descripción
FM309404	<b>ASI-102</b>	Para IND-102



Código	REF	Descripción
FM309405	<b>ASI-104</b>	Para IND-104



Código	REF	Descripción
FM309406	<b>ASI-105</b>	Para IND-105



Código	REF	Descripción
FM309407	<b>ASI-106</b>	Para IND-101 /106



Código	REF	Descripción
FM309408	<b>ASI-107</b>	Para IND-107



Código	REF	Descripción
FM309409	<b>ASI-108</b>	Para IND-103/108



Código	REF	Descripción
FM309410	<b>ASI-109</b>	Para IND-109



**CONSULTA  
NUESTRA  
GUIA DE REPUESTOS**



Código	REF	Descripción
FM309411	<b>ASI-110</b>	Para IND-111



Código	REF	Descripción
FM309412	<b>ASI-111</b>	Para IND-112



Código	REF	Descripción
FM309413	<b>ASI-112</b>	Para IND-113



Código	REF	Descripción
FM309414	<b>ASI-113</b>	Para IND-114



Código	REF	Descripción
FM309415	<b>ASI-114</b>	Para IND-115/116



Código	REF	Descripción
FM309416	<b>ASI-115</b>	Para IND-/117



Vávula para Urinario

Código	REF	Descripción
FM 30 6001	<b>LLA-77</b>	Push Button



Pantalla Para Urinario

Código	Descripción
BS 00 0501	Repuesto



Cuña para instalación de lavamanos

Código	REF	Descripción
FM 30 9501	<b>GRAP-11</b>	2 piezas pequeñas

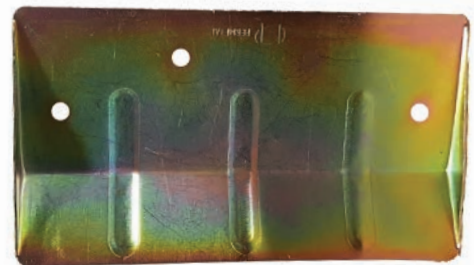

Cuña para instalación de lavamanos

Código	REF	Descripción
FM 30 9502	<b>GRAP-10</b>	1 pieza grande



Manguera para Jardín



Con conexión de Bronce

Código	Medida	Largo
FM 50 0001	1/2"	25 FT
FM 50 0002		50 FT
FM 50 0003		75 FT
FM 50 0004		100 FT
FM 50 0006	5/8"	25 FT
FM 50 0007		50 FT
FM 50 0008		75 FT
FM 50 0009	3/4"	100 FT
FM 50 0011		25 FT
FM 50 0012		50 FT
FM 50 0013		75 FT
FM 50 0014		100 FT



Manguera para Jardín Reforzada



Con conexión de Bronce

Código	Medida	Largo
FM 50 0021	1/2"	25 FT
FM 50 0022		50 FT
FM 50 0023		75 FT
FM 50 0024		100 FT
FM 50 0031	3/4"	25 FT
FM 50 0032		50 FT
FM 50 0033		75 FT
FM 50 0034		100 FT



Exhibidor de mangueras FERMETAL

FM 50 0199



Conexión para manguera HEMBRA 3/4" x espiga 1/2"

FM 50 1000 - CON-03



Conexión para manguera H/M 3/4" x 1/2"

FM 50 1001 - CON-02



Empacadura fibra 3/4"

RIGHI-051



Manguera transparente



Código	Medida	Largo
FM 50 0101	3/8"	100ft
FM 50 0111	1/2"	
FM 50 0121	5/8"	
FM 50 0131	3/4"	
FM 50 0141	1"	



Manguera transparente Industrial

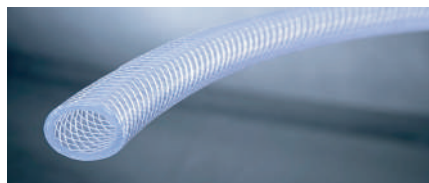

Código	Medida	Largo
FM 50 0151	3/8"	100ft
FM 50 0161	1/2"	
FM 50 0171	5/8"	
FM 50 0181	3/4"	
FM 50 0191	1"	

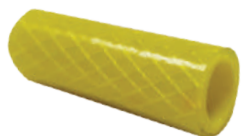

Manguera para Gas Reforzada



Código	Medida	Largo
FM 50 0051	3/8"	100 ft
FM 50 0055		300 ft



Manguera Industrial Reforzada Roja



Código	Medida	Largo
FM 50 0051	3/8"	100 ft



Conexión Manguera  
Macho x espiga

Código	REF	Descripción
DUR41050	00921	1/2" x 3/8"
DUR41051	00911	1/2" x 1/2"
DUR41052	00922	3/4" x 1/2"
DUR41053	00912	3/4" x 3/4"
DUR41056	00916	2" x 2"



Accesorios y Conexiones



Incluye  
Zapatilla

Conexión para llave manguera  
Hembra x Espiga

Código	REF	Descripción
DUR41091	02323	1/2" x 1/2"
DUR41092	02324	3/4" x 1/2"



Unión para Manguera

Código	REF	Descripción
DUR41061	00971	3/8"
DUR41062	00972	1/2"
DUR41063	00973	3/4"



Conexión Manguera  
Hembra x Espiga

Código	REF	Descripción
DUR41081	09201	1/2" x 1/2"
DUR41082	09202	3/4" x 3/4"



Codo Espiga para Manguera

Código	REF	Descripción
DUR41111	00941	1/2"
DUR41112	00942	3/4"



Válvula para manguera Espiga x Espiga

Código	REF	Descripción
DUR41151	00027	1/2"
DUR41152	00018	3/4"



Conexión Tee para manguera

Código	REF	Descripción
DUR41101	00961	1/2"
DUR41102	00962	3/4"



Válvula para manguera Espiga x Rosca

Código	REF	Descripción
DUR41162	00019	3/4" x 3/4"



# Jappy





**Mezcladora para lavamanos  
Tipo Sayco**

Código	REF	Descripción
JA 10 1051	JA-GRI-07	Mezcladora para lavamanos de 4"



**Mezcladora para lavamanos  
Tipo Sayco**

Código	REF	Descripción
JA 10 1052	JA-GRI-08	Mezcladora para lavamanos de 4"



**Llave para ducha de empotrar  
tipo Nibco 1/2"**

Código	REF	Descripción
JA 20 2001	JA-LLA-40	Cierre completo



**Llave para ducha de empotrar  
tipo Sayco 1/2"**

Código	REF	Descripción
JA 20 2002	JA-LLA-41	Cierre completo



Código	REF	Descripción
JA 10 1001	JA-GRI-12	Cierre completo

Mecanismo  
Cierre completo



Código	REF	Descripción
JA 10 1002	JA-GRI-41	Tipo Nibco

Mecanismo  
Cierre completo



Código	REF	Descripción
JA 10 1003	JA-GRI-42	Tipo Sayco

Mecanismo  
Cierre completo



Código	REF	Descripción
JA 10 1004	JA-GRI-52	Tipo King

Mecanismo  
Cierre completo



Código	REF	Descripción
JA 10 1005	JA-GRI-58	Puño Lev



Mecanismo  
1/4" de vuelta



Código	REF	Descripción
JA 20 1001	JA-LLA-32	Puño Twin



Mecanismo  
1/4" de vuelta



Código	REF	Descripción
JA 20 1002	JA-LLA-33	Puño Drop



Mecanismo  
1/4" de vuelta



Código	REF	Descripción
JA 20 1003	JA-LLA-35	Puño Neru



Mecanismo  
1/4" de vuelta



Código	REF	Descripción
JA 20 1004	JA-LLA-39	Puño Acrílico



Mecanismo  
1/4" de vuelta



Código	REF	Descripción
JA 20 1005	JA-LLA-42	Puño Sayco



Mecanismo  
1/4" de vuelta



Código	REF	Descripción
JA 20 1006	JA-LLA-71	Puño Trion



Llave de bola cromada de Zinc

Código	REF	Descripción
JA 20 3001	JA-LLA-21	1/2"
JA 20 3002	JA-LLA-22	3/4"



Llave para manguera

Código	REF	Descripción
JA 20 3003	JA-LLA-04	1/2" (Pared) x 3/4" Bronce



Teflón para plomería

Código	REF	Descripción
JA 80 0001	TEF-02-RD	3/4" x 23 ft



## Jappy

Calidad en tu hogar

Llave para lavamanos  
**Puño Drop**

JA-LLA-33



# Línea Agrícola





## Atomizador manual

Código	REF	Descripción
FM 50 5001	ATM-01	0.75 Litros
FM 50 5005	ATM-02	1.5 Litros
FM 50 5009	ATM-03	2 Litros



## Fumigadora manual

Código	REF	Descripción
FM 50 5021	FUM-10	5 Litros
FM 50 5025	FUM-11	10 Litros



## Fumigadora manual

Código	REF	Descripción
FM 50 5029	FUM-12	12 Litros
FM 50 5032	FUM-13	16 Litros
FM 50 5035	FUM-14	20 Litros



Repuesto de manilla

Código	REF	Descripción
FM 50 5901	MAN-50	Repuesto



Repuestos para brazo de fumigadora

Código	REF	Descripción
FM 50 5902	SPR-01	Repuesto



Manguera para fumigadora

Código	REF	Descripción
FM 50 5903	MAN-100	Repuesto



Repuesto de boquilla sencilla para fumigadora

Código	REF	Descripción
FM 50 5905	BOQ-01	Repuesto



Repuesto de boquilla doble para fumigadora

Código	REF	Descripción
FM 50 5904	BOQ-02	Repuesto



Repuesto de boquilla spray plano para fumigadora

Código	REF	Descripción
FM 50 5906	BOQ-03	Repuesto



Repuesto de boquilla para fumigadora

Código	REF	Descripción
FM 50 5907	BOQ-04	Repuesto



Uso: Construcción / Agrícola

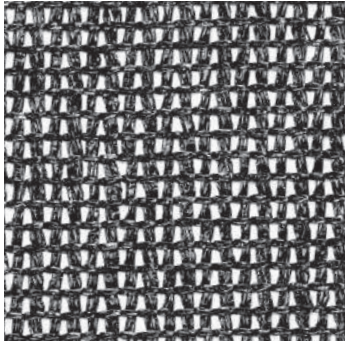

Tela de Sombra **80 %** - Color Negro

**TRIC-1001**

Ancho  
2.10 mts (7 ft)

Largo  
50 mts (165 ft)

**TRIC-1002**

Ancho  
4.20 mts (14 ft)

Largo  
50 mts (165 ft)

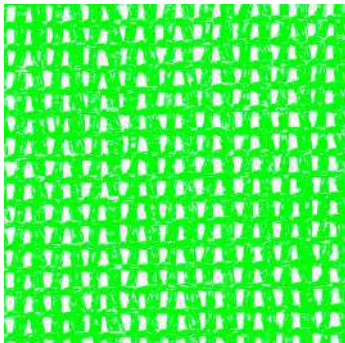

Tela de Sombra **80 %** - Color Verde

**TRIC-1011**

Ancho  
2.10 mts (7 ft)

Largo  
50 mts (165 ft)

**TRIC-1012**

Ancho  
4.20 mts (14ft)

Largo  
50 mts (165 ft)

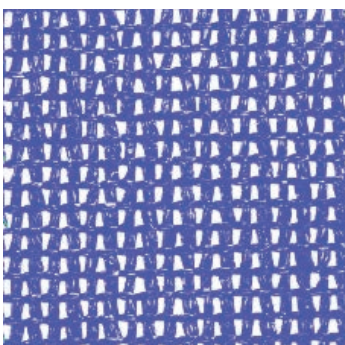

Tela de Sombra **80 %** - Color Azul

**TRIC-1013**

Ancho  
2.10 mts (7 ft)

Largo  
50 mts (165 ft)

**TRIC-1014**

Ancho  
4.20 mts (14ft)

Largo  
50 mts (165 ft)



Uso: Construcción / Avícola

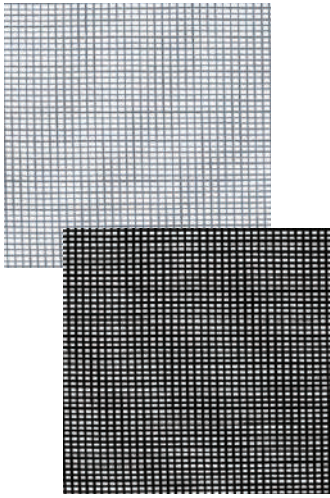

## Malla Mosquitero Fibra de Vidrio

### TRIC-3003 - Gris

Ancho 1.20 mts (4 ft)      Largo 30 mts (100 ft)

### TRIC-3006 - Negra

Ancho 1.20 mts (4 ft)      Largo 30 mts (100 ft)

### TRIC-3007 - Negra

Ancho 1.50 mts (5 ft)      Largo 30 mts (100 ft)

NUEVO

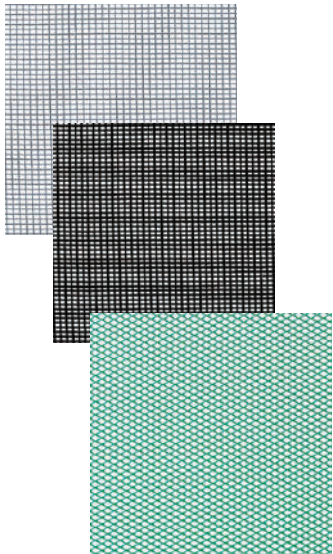
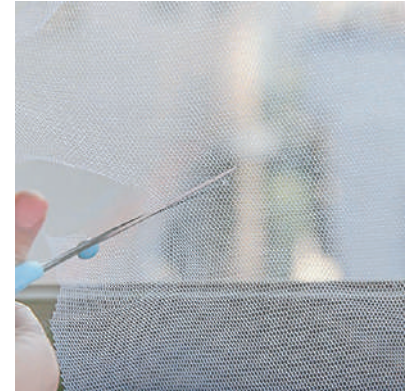

## Malla Mosquitero (Extruida)

### TRIC-3011 - NEGRO

Ancho 1.22 mts (4 ft)      Largo 30 mts (100 ft)

### TRIC-3012 - GRIS

Ancho 1.22 mts (4 ft)      Largo 30 mts (100 ft)

### TRIC-3013 - VERDE

Ancho 1.22 mts (4 ft)      Largo 30 mts (100 ft)



## Malla Warning Barrier Naranja

### TRIC-1201

Ancho 1.20 mts (4 ft)      Largo 30 mts (100 ft)



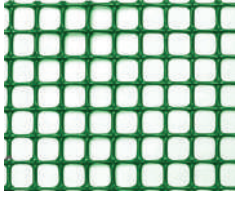

### TRIC-4021- Verde

Ancho 1.03 mts (3.2 ft) Largo 25 mts (82 ft)



### TRIC4006 - Verde

Ancho 1.50 mts (5 ft) Largo 25 mts (82 ft)

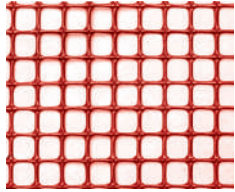

### TRIC-4022 - Roja

Ancho 1.03 mts (3.2 ft) Largo 25 mts (82 ft)

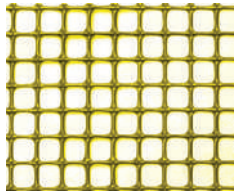

### TRIC-4023 - Amarilla

Ancho 1.03 mts (3.2 ft) Largo 25 mts (82 ft)

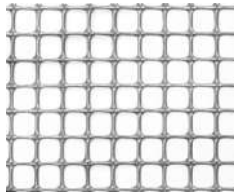
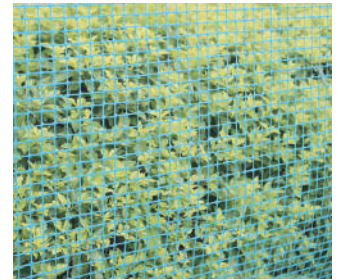

### TRIC-4024 - Blanca

Ancho 1.03 mts (3.2 ft) Largo 25 mts (82 ft)

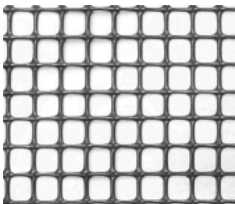

### TRIC-4025 - Negra

Ancho 1.03 mts (3.2 ft) Largo 25 mts (82 ft)



### TRIC-4005 - Negra

Ancho 1.50 mts (5 ft) Largo 25 mts (82 ft)

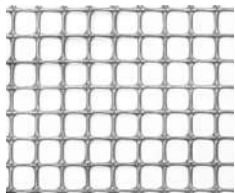

### TRIC-4026 - Transparente

Ancho 1.03 mts (3.2 ft) Largo 25 mts (82 ft)

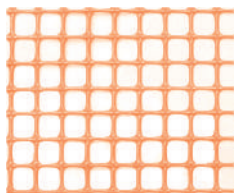

### TRIC-4027 -Mamey

Ancho 1.03 mts (3.2 ft) Largo 25 mts (82 ft)

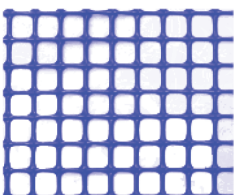

### TRIC-4028 -Azul

Ancho 1.03 mts (3.2 ft) Largo 25 mts (82 ft)

Para uso Avícola 

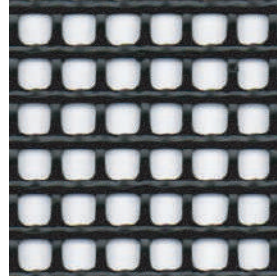

## Malla de secado de Café y Cacao

### TRIC-4000

Ancho  
1.45 mts (5ft)

Largo  
30 mts (100 ft)

### TRIC-4001

Ancho  
2.00 mts (6.56 ft)

Largo  
30 mts (100 ft)



## Malla Gallinero

### TRIC-4102 - 3/4"

Ancho  
1.83 mts (6 ft)

Largo  
30 mts (100 ft)

### TRIC-4103 - 1"

Ancho  
1.50 mts (5 ft)

Largo  
30 mts (100 ft)



## Malla Gallinero BOP - 25 x 30 mm

### TRIC-4111

Ancho  
1.83 mts (6 ft)

Largo  
50 mts (165ft)



## Malla Cerca Ciclonica

### TRIC-4051: 3x3

Ancho  
1.83 mts (6 ft)

Largo  
25 mts (82 ft)



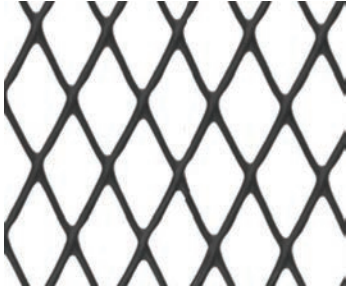

## Malla Diamante Negra

**TRIC-4031:** 3 x 3 Negra

**TRIC-4032:** 7 x 7 Negra

**TRIC-4033:** 11 x 11 Negra



Ancho  
1 mts (3.2 ft)



Largo  
30 mts (100 ft)

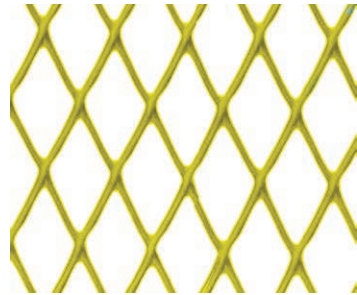

## Malla Diamante Amarilla

**TRIC-4041:** 3 x 3 Amarilla

**TRIC-4042:** 7 x 7 Amarilla



Ancho  
1 mts (3.2 ft)



Largo  
30 mts (100 ft)



## MONOMANDOS

REFERENCIA	CODIGO	DESCRIPCION	MARCA	REPUESTO REFERENCIA	REPUESTO CODIGO	UdeM
GRI-02	FM110001	GRI-02: MONOMANDO FREGADERO 10" C/CONEXION BRONCE	FERMETAL	BAS-35	FM190001	PIEZA
GRI-25	FM110002	GRI-25: MONOMANDO FREGADERO 10"	FERMETAL	BAS-25	FM190002	PIEZA
GRI-36	FM110101	GRI-36: MONOMANDO PICO ROCIADOR EXTENSIBLE 10" C/MANGUERAS	FERMETAL	BAS-25	FM190002	PIEZA
GRI-40	FM112001	GRI-40: MONOMANDO DUCHA SOBREPONER C/ REGADERA Y SOPORTE	FERMETAL	BAS-25	FM190002	PIEZA
GRI-53	FM111201	GRI-53: MONOMANDO LAVAMANOS CON BASE 4"	FERMETAL	BAS-25	FM190002	PIEZA
GRI-66	FM111001	GRI-66: MONOMANDO LAVAMANOS	FERMETAL	BAS-35	FM190001	PIEZA
GRI-72	FM100006	GRI-72: MONOMANDO LAVAMANOS CURVO C/MANGUERAS 3/8"x10mm	PREMIUM	BAS-25	FM190002	PIEZA
GRI-73	FM111002	GRI-73: MONOMANDO LAVAMANOS (SIN BASE) C/MANGUERAS 10mm x 3/8"	FERMETAL	BAS-25	FM190002	PIEZA
GRI-74	FM111003	GRI-74: MONOMANDO LAVAMANOS (SIN BASE) C/MANGUERAS 10mm x 3/8"	FERMETAL	BAS-25	FM190002	PIEZA
GRI-75	FM111004	GRI-75: MONOMANDO LAVAMANOS (SIN BASE) C/MANGUERAS 10mm x 3/8"	FERMETAL	BAS-25	FM190002	PIEZA
GRI-76	FM112002	GRI-76: MONOMANDO DUCHA SOBREPONER C/ REGADERA Y SOPORTE	FERMETAL	BAS-25	FM190002	PIEZA
GRI-77	FM112003	GRI-77: MONOMANDO DUCHA SOBREPONER C/ REGADERA Y SOPORTE	FERMETAL	BAS-25	FM190002	PIEZA
GRI-78	FM112004	GRI-78: MONOMANDO DUCHA SOBREPONER C/ REGADERA Y SOPORTE	FERMETAL	BAS-25	FM190002	PIEZA
GRI-79	FM125101	GRI-79: MONOMANDO DUCHA SOBREPONER C/ REGADERA Y SOPORTE	PREMIUM	BAS-25	FM190002	PIEZA
GRI-80	FM111000	GRI-80: MONOMANDO LAVAMANOS (SIN BASE) C/MANGUERAS 10mm x 3/8"	FERMETAL	BAS-25	FM190002	PIEZA
GRI-81	FM112000	GRI-81: MONOMANDO DUCHA SOBREPONER C/ REGADERA Y SOPORTE S/PICO	FERMETAL	BAS-25	FM190002	PIEZA
GRI-82	FM124151	GRI-82: MONOMANDO LAVAMANOS CURVO SIN BASE *SATINADO	FERMETAL	BAS-25	FM190002	PIEZA
GRI-83	FM125151	GRI-83: MONOMANDO DUCHA SOBREPONER C/ REGADERA Y SOPORTE *SATINADO	FERMETAL	BAS-25	FM190002	PIEZA
GRI-401	FM125001	GRI-401: MONOMANDO DUCHA EMBUTIR 40mm DE LUJO	PREMIUM	VAS-04	FM190011	PIEZA
GRI-511	FM124103	GRI-511: MONOMANDO LAVAMANOS REDONDO SIN BASE	PREMIUM	REP-218	FM190001	PIEZA
GRI-515	FM125102	GRI-515: MONOMANDO DUCHA SOBREPONER C/ REGADERA Y SOPORTE P/GRI-511	PREMIUM	REP-218	FM190001	PIEZA
GRI-517	FM125301	GRI-517: COLUMNA DUCHA CON MONOMANDO P/GRI-511	PREMIUM	REP-218	FM190001	PIEZA
GRI-521	FM124104	GRI-521: MONOMANDO LAVAMANOS CUADRADO SIN BASE	PREMIUM	REP-218	FM190001	PIEZA
GRI-525	FM125103	GRI-525: MONOMANDO DUCHA SOBREPONER C/ REGADERA Y SOPORTE P/GRI-521	PREMIUM	REP-218	FM190001	PIEZA
GRI-527	FM125302	GRI-527: COLUMNA DUCHA CON MONOMANDO P/GRI-521	PREMIUM	REP-218	FM190001	PIEZA
GRI-600	UQ101001	GRI-600: MONOMANDO FREGADERO ALTO C/CUELLO FLEXIBLE	UNIQUE	REP-218	FM190001	PIEZA
GRI-610	UQ101020	GRI-610: MONOMANDO FREGADERO CUADRADO	UNIQUE	REP-218	FM190001	PIEZA
GRI-611	UQ101021	GRI-611: MONOMANDO FREGADERO ALTO	UNIQUE	REP-218	FM190001	PIEZA
GRI-700	FM110011	GRI-700: MONOMANDO FREGADERO 10" PRIME	FERMETAL	BAS-35	FM190001	PIEZA
GRI-701	FM110012	GRI-701: MONOMANDO FREGADERO 10" ELITE	FERMETAL	BAS-35	FM190001	PIEZA
GRI-702	FM110013	GRI-702: MONOMANDO FREGADERO 10" FLEXIBLE NEGRA ELITE	FERMETAL	BAS-35	FM190001	PIEZA
GRI-704	FM123021	GRI-704: MONOMANDO FREGADERO P/1 HUECO	PREMIUM	BAS-25	FM190002	PIEZA
GRI-705	FM123022	GRI-705: MONOMANDO FREGADERO SATINADO P/1 HUECO	PREMIUM	BAS-25	FM190002	PIEZA
GRI-706	FM110121	GRI-706: MONOMANDO C/CABEZAL FLEXIBLE	FERMETAL	BAS-25	FM190002	PIEZA
GRI-974	FM113000	GRI-974: COLUMNA DE DUCHA CON MONOMANDO (JUEGO CON MONOMANDO GRI-74)	PREMIUM	BAS-25/REP-2	FM190002	PIEZA
GRI-975	FM113001	GRI-975: COLUMNA DE DUCHA CON MONOMANDO (JUEGO CON MONOMANDO GRI-75)	PREMIUM	BAS-25/REP-2	FM190002	PIEZA
INOX-31	FMSS0070	INOX-31: MONOMANDO FREGADERO 10" CUADRADO CUELLO CISNE *A/INOX	INOX	REP-218	FM190001	PIEZA
INOX-121	FMSS0150	INOX-121: MONOMANDO LAVAMANOS *A/INOX	INOX	REP-218	FM190001	PIEZA
INOX-125	FMSS0151	INOX-125: MONOMANDO DUCHA P/INOX-121 *A/INOX	INOX	REP-218	FM190001	PIEZA
INOX-131	FMSS0155	INOX-131: MONOMANDO LAVAMANOS BAJO CUADRADO *A/INOX	INOX	REP-218	FM190001	PIEZA
INOX-133	FMSS0156	INOX-133: MONOMANDO LAVAMANOS ALTO CUADRADO *A/INOX	INOX	REP-218	FM190001	PIEZA
INOX-135	FMSS0157	INOX-135: MONOMANDO DUCHA P/INOX-131/133 *A/INOX	INOX	REP-218	FM190001	PIEZA
INOX-137	FMSS0158	INOX-137: COLUMNA DUCHA CON MONOMANDO P/INOX-131/133 *A/INOX	INOX	REP-218	FM190001	PIEZA

## MEZCLADORAS

REFERENCIA	CODIGO	DESCRIPCION	MARCA	REPUESTO REFERENCIA	REPUESTO CODIGO	UdeM
GRI-07	FM103002	GRI-07: MEZCLADORA LAVAMANOS 4" TIPO SAYCO CIERRE 1/4 METALICA	FERMETAL	VAS-10	FM190012	PAR
GRI-12	FM101001	GRI-12: MEZCLADORA FREGADERO PICO 10" PP CIERRE 1/4 METALICA	FERMETAL	VAS-10	FM190012	PAR
GRI-15	FM103001	GRI-15: MEZCLADORA LAVAMANO 4" PP CIERRE 1/4 METALICA	FERMETAL	VAS-10	FM190012	PAR
GRI-17	FM100000	GRI-17: MEZCLADORA FREGADERO 8" PP CROMADO CIERRE 1/4 ABS CROMADO	FERMETAL	BAS-24	FM190004	PAR
GRI-26	FM102002	GRI-26: MEZCLADORA LAVAMANO 4" LEV CIERRE 1/4 ABS CROMADO	FERMETAL	BAS-31	FM190008	PAR
GRI-32	FM101002	GRI-32: MEZCLADORA FREGADERO PICO 90° 10" LEV CIERRE 1/4 METALICA	FERMETAL	VAS-10	FM190012	PAR
GRI-39	FM101003	GRI-39: MEZCLADORA FREGADERO PICO 10" TIPO SAYCO VASTAGO TRADICIONAL METALICA	FERMETAL	VAS-10	FM190012	PAR
GRI-41	FM101004	GRI-41: MEZCLADORA FREGADERO 10" TIPO NIBCO METALICA	FERMETAL	BAS-02	FM190019	PAR
GRI-42	FM101005	GRI-42: MEZCLADORA FREGADERO PICO 10" TIPO SAYCO CIERRE 1/4	FERMETAL	BAS-02	FM190019	PAR
GRI-43	FM101006	GRI-43: MEZCLADORA FREGADERO PICO 10" T/NIBCO METALICA *PESADA*	FERMETAL	BAS-02	FM190019	PAR
GRI-46	FM103005	GRI-46: MEZCLADORA LAVAMANOS 4" DROP CIERRE 1/4 METALICA	FERMETAL	VAS-10	FM190012	PAR
GRI-52	FM101007	GRI-52: MEZCLADORA FREGADERO PICO 10" KING CIERRE 1/4 METALICA	FERMETAL	VAS-10	FM190012	PAR
GRI-55	FM103023	GRI-55: MEZCLADORA LAVAMANOS CUELLO CISNE 4" LEV CIERRE 1/4 METALICA	FERMETAL	VAS-10	FM190012	PAR
GRI-56	FM103006	GRI-56: MEZCLADORA LAVAMANOS 4" LEV CIERRE 1/4 METALICA	FERMETAL	VAS-10	FM190012	PAR
GRI-58	FM101008	GRI-58: MEZCLADORA FREGADERO PICO 10" LEV CIERRE 1/4 METALICA	FERMETAL	VAS-10	FM190012	PAR
GRI-59	FM101009	GRI-59: MEZCLADORA FREGADERO PICO 90° 10" DROP CIERRE 1/4 METALICA	FERMETAL	VAS-10	FM190012	PAR
GRI-62	FM101011	GRI-62: MEZCLADORA FREGADERO PICO 90° 10" KING CIERRE 1/4 METALICA	FERMETAL	VAS-10	FM190012	PAR
GRI-67	FM100001	GRI-67: MEZCLADORA FREGADERO 8" CUELLO CISNE LEV II CIERRE 1/4 ABS CROMADO	FERMETAL	BAS-31	FM190008	PAR
GRI-69	FM100003	GRI-69: MEZCLADORA FREGADERO 8" CUELLO CISNE KING II CIERRE 1/4 ABS CROMADO	FERMETAL	BAS-31	FM190008	PAR
GRI-100	FM121001	GRI-100: MEZCLADORA LAVAMANOS 4" CROSS CIERRE 1/4 METALICA	PREMIUM	VAS-01	FM190009	PAR
GRI-101	FM121002	GRI-101: MEZCLADORA LAVAMANOS 4" WING CIERRE 1/4 METALICA	PREMIUM	VAS-01	FM190009	PAR
GRI-102	FM121003	GRI-102: MEZCLADORA LAVAMANOS 4" WORLD CIERRE 1/4 METALICA	PREMIUM	VAS-01	FM190009	PAR
GRI-103	FM121004	GRI-103: MEZCLADORA LAVAMANOS 4" LEG CIERRE 1/4 METALICA	PREMIUM	VAS-01	FM190009	PAR
GRI-104	FM121005	GRI-104: MEZCLADORA LAVAMANOS 4" CROWN CIERRE 1/4 METALICA	PREMIUM	VAS-01	FM190009	PAR
GRI-150	FM121101	GRI-150: MEZCLADORA LAVAMANOS CUELLO DE CISNE 4" CROSS CIERRE 1/4 METALICA	PREMIUM	VAS-01	FM190009	PAR
GRI-151	FM121102	GRI-151: MEZCLADORA LAVAMANOS CUELLO DE CISNE 4" WING CIERRE 1/4 METALICA	PREMIUM	VAS-01	FM190009	PAR
GRI-152	FM121103	GRI-152: MEZCLADORA LAVAMANOS CUELLO DE CISNE 4" WORLD CIERRE 1/4 METALICA	PREMIUM	VAS-01	FM190009	PAR
GRI-153	FM121104	GRI-153: MEZCLADORA LAVAMANOS CUELLO DE CISNE 4" LEG CIERRE 1/4 METALICA	PREMIUM	VAS-01	FM190009	PAR
GRI-154	FM121105	GRI-154: MEZCLADORA LAVAMANOS CUELLO DE CISNE 4" CROWM CIERRE 1/4 METALICA	PREMIUM	VAS-01	FM190009	PAR
GRI-200	FM120001	GRI-200: MEZCLADORA FREGADERO 8" CUELLO CISNE CROSS CIERRE 1/4 METALICA	PREMIUM	VAS-01	FM190009	PAR
GRI-201	FM120002	GRI-201: MEZCLADORA FREGADERO 8" CUELLO CISNE WING CIERRE 1/4 METALICA	PREMIUM	VAS-01	FM190009	PAR
GRI-202	FM120003	GRI-202: MEZCLADORA FREGADERO 8" CUELLO CISNE WORLD CIERRE 1/4 METALICA	PREMIUM	VAS-01	FM190009	PAR
GRI-203	FM120004	GRI-203: MEZCLADORA FREGADERO 8" CUELLO CISNE LEG CIERRE 1/4 METALICA	PREMIUM	VAS-01	FM190009	PAR
GRI-204	FM120005	GRI-204: MEZCLADORA FREGADERO 8" CUELLO CISNE CROWN CIERRE 1/4 METALICA	PREMIUM	VAS-01	FM190009	PAR
GRI-210	FM120101	GRI-210: MEZCLADORA FREGADERO 8" CROSS *SATINADA CIERRE 1/4 METALICA	PREMIUM	VAS-01	FM190009	PAR
GRI-211	FM120102	GRI-211: MEZCLADORA FREGADERO 8" WING *SATINADA CIERRE 1/4 METALICA	PREMIUM	VAS-01	FM190009	PAR
GRI-212	FM120103	GRI-212: MEZCLADORA FREGADERO 8" WORLD *SATINADA CIERRE 1/4 METALICA	PREMIUM	VAS-01	FM190009	PAR
GRI-213	FM120104	GRI-213: MEZCLADORA FREGADERO 8" LEG *SATINADA CIERRE 1/4 METALICA	PREMIUM	VAS-01	FM190009	PAR
GRI-214	FM120105	GRI-214: MEZCLADORA FREGADERO 8" CROWN *SATINADA CIERRE 1/4 METALICA	PREMIUM	VAS-01	FM190009	PAR
GRI-220	FM120500	GRI-220: MEZCLADORA FREGADERO 8" CUELLO 90° *SATINADA CIERRE 1/4 METALICA	PREMIUM	REP-223	FM190015	PAR
GRI-221	FM120010	GRI-221: MEZCLADORA FREGADERO 8" CUELLO 90° CIERRE 1/4 METALICA	PREMIUM	REP-223	FM190015	PAR
GRI-222	FM120011	GRI-222: MEZCLADORA FREGADERO 8" CUELLO CISNE CIERRE 1/4 METALICA	PREMIUM	REP-224	FM190016	PAR
GRI-223	FM120012	GRI-223: MEZCLADORA FREGADERO 8" CUELLO FLEXIBLE CIERRE 1/4 ABS/METAL	PREMIUM	REP-224	FM190016	PAR
GRI-224	FM120013	GRI-224: MEZCLADORA FREGADERO 8" CUELLO 45° CIERRE 1/4 METALICA	PREMIUM	REP-224	FM190016	PAR
GRI-250	FM120501	GRI-250: MEZCLADORA FREGADERO/BAR CUELLO CISNE CROSS DOBLE CIERRE 1/4 METALICA	PREMIUM	VAS-01	FM190009	PAR
GRI-251	FM120502	GRI-251: MEZCLADORA FREGADERO/BAR CUELLO CISNE CROSS SENCILLA CIERRE 1/4 METALICA	PREMIUM	VAS-01	FM190009	PAR
GRI-252	FM120503	GRI-252: MEZCLADORA FREGADERO/BAR CUELLO CISNE CROWN SENCILLA CIERRE 1/4 METALICA	PREMIUM	VAS-01	FM190009	PAR
GRI-253	FM120504	GRI-253: MEZCLADORA FREGADERO/BAR CUELLO CISNE CROWN DOBLE CIERRE 1/4 METALICA	PREMIUM	VAS-01	FM190009	PAR
GRI-612	UQ101100	GRI-612: MEZCLADORA CUELLO CISNE 10" CROMADA	UNIQUE	REP-221	FM190013	PAR
GRI-613	UQ101101	GRI-613: MEZCLADORA CUADRADA CUELLO CISNE 10" CROMADA	UNIQUE	REP-222	FM190014	PAR
GRI-614	UQ101102	GRI-614: MEZCLADORA CUADRADA CUELLO CISNE 10" *SATINADA	UNIQUE	REP-222	FM190014	PAR
GRI-1013C	FM100008	GRI-1013C: MEZCLADORA FREGADERO 8" CUELLO CISNE DROP CIERRE 1/4 ABS CROMADO	FERMETAL	V-1013	FM190006	PAR
GRI-1013P	FM100007	GRI-1013P: MEZCLADORA FREGADERO 8" CUELLO CISNE LEV CIERRE 1/4 ABS CROMADO	FERMETAL	V-1013	FM190006	PAR
GRI-3000	FM101051	GRI-3000: MEZCLADORA FREGADERO KING C/FLEXIBLE 2 POSICIONES	FERMETAL	V-1013	FM190006	PAR
GRI-3001	FM101052	GRI-3001: MEZCLADORA FREGADERO KING C/FLEXIBLE	FERMETAL	V-1013	FM190006	PAR
GRI-3002	FM101061	GRI-3002: MEZCLADORA FREGADERO LEV C/FLEXIBLE 2 POSICIONES	FERMETAL	V-1013	FM190006	PAR
GRI-3003	FM101062	GRI-3003: MEZCLADORA FREGADERO LEV C/FLEXIBLE	FERMETAL	V-1013	FM190006	PAR
INOX-11	FMSS0050	INOX-11: MEZCLADORA FREGADERO 8" CUELLO CISNE *A/INOX	INOX	REP-223	FM190015	PAR
M-014	FM100009	M-014: MEZCLADORA FREGADERO 8" CUELLO 90° LEV CIERRE 1/4 ABS CROMADO	FERMETAL	BAS-31	FM190008	PAR

## GRIFERÍAS (1 VÍA)

REFERENCIA	CODIGO	DESCRIPCION	MARCA	REPUESTO REFERENCIA	REPUESTO CODIGO	UdeM
GRI-27	FM101012	GRI-27: MEZCLADORA FREGADERO/BAR SENCILLA CUELLO DE CISNE KING II CIERRE 1/4 METALICA	FERMETAL	BAS-23	FM190003	PIEZA
GRI-28	FM101013	GRI-28: MEZCLADORA FREGADERO/BAR DOBLE CUELLO DE CISNE KING II CIERRE 1/4 METALICA	FERMETAL	BAS-23	FM190003	PIEZA
GRI-37	FM101014	GRI-37: MEZCLADORA FREGADERO/BAR SENCILLA CUELLO DE CISNE POMO CRUZ CIERRE 1/4 METALICA	FERMETAL	BAS-23	FM190003	PIEZA
GRI-38	FM101015	GRI-38: MEZCLADORA FREGADERO/BAR DOBLE CUELLO DE CISNE POMO CRUZ CIERRE 1/4 METALICA	FERMETAL	BAS-23	FM190003	PIEZA
GRI-225	FM120510	GRI-225: MEZCLADORA FREGADERO/BAR CUELLO CISNE SENCILLA CIERRE 1/4 METALICA	PREMIUM	REP-225	FM190017	PIEZA
GRI-226	FM162010	GRI-226: GRIFERIA LAVAMANOS 1 VIA CROMADA P/CRUZ 1/2" CIERRE 1/4	PREMIUM	REP-226	FM190018	PIEZA
GRI-227	FM162011	GRI-227: GRIFERIA LAVAMANOS 1 VIA CROMADA P/PALANCA 1/2" CIERRE 1/4	PREMIUM	REP-226	FM190018	PIEZA
GRI-228	FM162012	GRI-228: GRIFERIA LAVAMANOS 1 VIA CROMADA BAJA 1/2" CIERRE 1/4	PREMIUM	REP-226	FM190018	PIEZA
GRI-229	FM162013	GRI-229: GRIFERIA LAVAMANOS 1 VIA CROMADA ALTA 1/2" CIERRE 1/4	PREMIUM	REP-226	FM190018	PIEZA
INOX-01	FMSS0000	INOX-01: GRIFERIA FREGADERO 1 VIA *A/INOX	INOX	REP-225	FM190017	PIEZA
INOX-02	FMSS0001	INOX-02: GRIFERIA FREGADERO 1 VIA FLEXIBLE *A/INOX	INOX	REP-225	FM190017	PIEZA
INOX-101	FMSS0100	INOX-101: GRIFERIA LAVAMANOS 1 VIA 1/2" *A/INOX	INOX	REP-225	FM190017	PIEZA

## LLAVES INDIVIDUALES (LAVAMANOS)

REFERENCIA	CODIGO	DESCRIPCION	MARCA	REPUESTO REFERENCIA	REPUESTO CODIGO	UdeM
LLA-03	FM151011	LLA-03: LLAVE LAVAMANOS INDIVIDUAL *P/ACRILICO BOTON AZUL METALICA CIERRE 1/4	FERMETAL	BAS-23	FM190003	PIEZA
LLA-32	FM151002	LLA-32: LLAVE LAVAMANOS INDIVIDUAL *TWIN METALICA CIERRE 1/4	FERMETAL	BAS-23	FM190003	PIEZA
LLA-33	FM151003	LLA-33: LLAVE LAVAMANOS INDIVIDUAL *DROP METALICA CIERRE 1/4	FERMETAL	BAS-23	FM190003	PIEZA
LLA-35	FM151005	LLA-35: LLAVE LAVAMANOS INDIVIDUAL P/TRIANGULAR *NERU METALICA CIERRE 1/4	FERMETAL	BAS-23	FM190003	PIEZA
LLA-38	FM151031	LLA-38: LLAVE LAVAMANOS INDIVIDUAL METALICA PUSH BUTTOM	FERMETAL	BAS-26	FM190007	PIEZA
LLA-39	FM151012	LLA-39: LLAVE LAVAMANOS INDIVIDUAL *P/ACRILICO REDONDO METALICA CIERRE 1/4	FERMETAL	BAS-23	FM190003	PIEZA
LLA-42	FM151007	LLA-42: LLAVE LAVAMANOS INDIVIDUAL *T/SAYCO CIERRE 1/4	FERMETAL	BAS-23	FM190003	PIEZA
LLA-100	FM161001	LLA-100: LLAVE LAVAMANOS INDIVIDUAL CROSS CIERRE 1/4	PREMIUM	VAS-01	FM190009	PAR
LLA-101	FM161002	LLA-101: LLAVE LAVAMANOS INDIVIDUAL CROWN CIERRE 1/4	PREMIUM	VAS-01	FM190009	PAR

## LLAVES INDIVIDUALES (DUCHA)

REFERENCIA	CODIGO	DESCRIPCION	MARCA	REPUESTO REFERENCIA	REPUESTO CODIGO	UdeM
LLA-02	FM152001	LLA-02: LLAVE DUCHA EMPOTRAR INDIVIDUAL *T/PP 1/2" CIERRE 1/4	FERMETAL	BAS-21	FM190005	PIEZA
LLA-40	FM152002	LLA-40: LLAVE DUCHA EMPOTRAR INDIVIDUAL TIPO *NIBCO 1/2" CIERRE 1/4	FERMETAL	BAS-21	FM190005	PIEZA
LLA-41	FM152003	LLA-41: LLAVE DUCHA EMPOTRAR INDIVIDUAL TIPO *SAYCO 1/2" CIERRE 1/4	FERMETAL	BAS-21	FM190005	PIEZA
LLA-70	FM152004	LLA-70: LLAVE DUCHA EMPOTRAR INDIVIDUAL *4 ESTRIAS 1/2" CIERRE 1/4	FERMETAL	BAS-21	FM190005	PIEZA
LLA-111	FM162001	LLA-111: LLAVE DUCHA EMPOTRAR INDIVIDUAL *CROSS" CIERRE 1/4	PREMIUM	VAS-02	FM190010	PIEZA
LLA-112	FM162002	LLA-112: LLAVE DUCHA EMPOTRAR INDIVIDUAL *CROWN" CIERRE 1/4	PREMIUM	VAS-02	FM190010	PIEZA



## SANITARIOS

REFERENCIA SANITARIO	CODIGO SANITARIO	REFERENCIA ASIENTO DE INODORO	CODIGO- ASIENTO DE INODORO
<b>SAN-36</b>	FM300000	<b>TAP-003 / TAP-002</b>	FM309400 - FM309402
<b>IND-01 / IND-10</b>	FM300001	<b>TAP-001- TAP-004</b>	FM309401 - FM309403
<b>IND-02</b>	FM300002	<b>TAP-001- TAP-004</b>	FM309401 - FM309403
<b>IND-07</b>	FM300003	<b>TAP-003 / TAP-002</b>	FM309400 - FM309402
<b>IND-101</b>	FM305012	<b>ASI-106</b>	FM309407
<b>IND-102</b>	FM305013	<b>ASI-102</b>	FM309404
<b>IND-103</b>	FM305014	<b>ASI-108</b>	FM309409
<b>IND-104</b>	FM305015	<b>ASI-104</b>	FM309405
<b>IND-105</b>	FM305016	<b>ASI-105</b>	FM309406
<b>IND-106</b>	FM305017	<b>ASI-106</b>	FM309407
<b>IND-107</b>	FM305018	<b>ASI-107</b>	FM309408
<b>IND-108</b>	FM305019	<b>ASI-108</b>	FM309409
<b>IND-109</b>	FM305020	<b>ASI-109</b>	FM309410

